



Instruction Manual



EL-FLOW® Prestige series Thermal Mass Flow Meters/Controllers

Doc. no.: 9.17.084 rev. N Date: 23-09-2020



ATTENTION

**Please read this document carefully before installing and operating the product.
Not following the guidelines could result in personal injury and/or damage to the equipment.**



Copyright

© 2020 Bronkhorst High-Tech B.V.

All rights reserved. No part of this publication may be reproduced, distributed, or transmitted in any form or by any means, without the prior written permission of the publisher.

Disclaimer

This document has been reviewed and is believed to be accurate. Bronkhorst High-Tech B.V. does not assume liability for errors, inaccuracies or absence of information. The material in this document merely serves information and illustration purposes; no rights can be derived from its contents.

Bronkhorst High-Tech B.V. reserves the right to modify or improve its products and documentation without informing anyone. As such, the information contained in this document is subject to change without notice. Device specifications and the contents of the package may deviate from what is stated in this document.

Symbols in this document



Important information. Disregarding this information could increase the risk of damage to the equipment, or the risk of personal injuries.



Helpful information. This information will facilitate the use of the instrument and/or contribute to its optimal performance.



Additional information available on the internet or from your Bronkhorst representative.

Receipt of equipment

Check the outside packaging box for damage incurred during shipment. If the box is damaged, the local carrier must be notified at once regarding his liability, if so required. At the same time a report should be submitted to your Bronkhorst representative.

Carefully remove the equipment from the box. Verify that the contents of the package was not damaged during shipment. Should the equipment be damaged, the local carrier must be notified at once regarding his liability, if so required. At the same time a report should be submitted to your Bronkhorst representative.



- *Check the packing list to ensure that you received all of the items included in the scope of delivery*
- *Do not discard spare or replacement parts with the packaging material*

Refer to [Removal and return instructions](#) about return shipment procedures.

Equipment storage

- The equipment should be stored in its original package in a climate controlled storage location.
- Care should be taken not to subject the equipment to excessive temperatures or humidity.
- See technical specifications for information about required storage conditions.

Warranty

Bronkhorst® products are warranted against defects in material and workmanship for a period of three years from the date of shipment, provided they are used in accordance with the ordering specifications and not subject to abuse or physical damage. Products that do not operate properly during this period may be repaired or replaced at no charge. Repairs are normally warranted for one year or the balance of the original warranty, whichever is the longer.



See also section 9 (Guarantee) of the Conditions of sales:
www.bronkhorst.com/int/about/conditions-of-sales/

The warranty includes all initial and latent defects, random failures, and indeterminable internal causes. It excludes failures and damage caused by the customer, such as contamination, improper electrical hook-up, physical shock etc.

Re-conditioning of products primarily returned for warranty service that is partly or wholly judged non-warranty may be charged for.

Bronkhorst High-Tech B.V. or affiliated company prepays outgoing freight charges when any part of the service is performed under warranty, unless otherwise agreed upon beforehand. The costs of unstamped returns are added to the repair invoice. Import and/or export charges as well as costs of foreign shipping methods and/or carriers are paid by the customer.

General safety precautions

This product is intended for use by qualified personnel who recognize shock hazards and are familiar with the safety precautions required to avoid possible injury. Read the operating information carefully before using the product.

Before operating, make sure the line cord is connected to a properly grounded power receptacle. Inspect the connecting cables for cracks or breaks before each use.

The equipment and accessories must be used in accordance with their specifications and operating instructions, otherwise the safety of the equipment may be impaired.

Opening the equipment is not allowed. There are no user serviceable parts inside. In case of a defect please return the equipment to Bronkhorst High-Tech B.V.

One or more warning signs may be attached to the product. These signs have the following meaning:



General warning; consult the instruction manual for handling instructions



Surface may get hot during operation



Shock hazard; electrical parts inside

To maintain protection from electric shock and fire, replacement components must be obtained from Bronkhorst. Standard fuses, with applicable national safety approvals, may be used if the rating and type are the same. Other components that are not safety related may be obtained from other suppliers, as long as they are equivalent to the original component. Selected parts should be obtained only through Bronkhorst, to maintain accuracy and functionality of the product. If you are unsure about the relevance of a replacement component, contact your Bronkhorst representative for information.

Table of contents

1	Introduction	7
1.1	Scope of this manual	7
1.2	Intended use	7
1.3	Product description	7
1.3.1	EL-FLOW® Prestige PI	8
1.4	Documentation	9
1.5	Model key	10
2	Starting up	11
2.1	Functional properties	11
2.2	Operating conditions	11
2.3	Mounting	11
2.4	Piping requirements	12
2.5	Fluid connection	12
2.6	Electrical connection	12
2.7	Analog / digital communication	13
2.7.1	Analog / local communication	13
2.7.2	Digital RS232 communication	13
2.7.3	Digital RS485 / fieldbus communication	13
2.8	Micro switch operation	14
2.9	Powering up and powering down	14
2.10	First use	14
2.11	Calibration	14
2.12	Maintenance	14
3	Basic operation	15
3.1	Mass flow measurement and control	15
3.1.1	Changing fluid set, range or operating conditions	15
3.1.2	Valve Safe State	17
3.2	Communication interfaces	17
3.2.1	Using multiple interfaces	17
3.3	Analog operation	18
3.3.1	Cabling	18
3.4	Basic RS232 operation	18
3.4.1	Cabling	19
3.4.1.1	RS232 communication	19
3.4.1.2	RS232 communication powered by fieldbus	20
3.4.1.3	E-8000 power supply, readout and control	20
3.4.1.4	BRIGHT readout and control	21
3.4.2	FlowDDE	21
3.4.3	Software (DDE applications)	22
3.4.4	Baud rate setup	22
3.5	Basic RS485 operation (FLOW-BUS/Modbus)	23
3.5.1	Cabling	24
3.5.2	Software	25
3.5.3	Baud rate, node address and parity setup	25
3.6	Other fieldbus configurations	26
3.6.1	Baud rate, node address and parity setup	27

3.7	LED indications	27
3.8	Micro switch functions	29
3.8.1	Normal operating functions	29
3.8.2	Power-up functions	30
3.8.3	Control mode - readout/change	30
3.8.4	Network settings - readout/change	31
3.9	Basic parameters and properties	32
3.9.1	General	32
3.9.2	Measurement and control (basic)	33
3.9.2.1	Secondary outputs	34
3.9.3	Device identification	34
3.9.4	Alarms and counter	35
3.10	Adjusting zero point	35
3.10.1	Manual procedure	35
3.10.2	Digital procedure	36
4	Advanced operation	37
4.1	Sealing material compatibility	37
4.2	Advanced parameters and properties	38
4.2.1	Measurement and control (advanced)	38
4.2.2	Special parameters	39
4.2.3	Fluid set	40
4.2.3.1	Advanced fluid set parameters	42
4.2.3.2	Fluid mixture parameters	43
4.2.4	Alarms	44
4.2.5	Counter	45
4.2.6	Network configuration	47
4.2.7	Master/slave configuration (FLOW-BUS)	48
4.3	Special features	49
4.3.1	Customized I/O options (pin 5)	49
4.3.2	Changing default control mode	51
5	Troubleshooting and service	52
5.1	Errors and warnings	52
5.2	Restoring factory settings	52
5.3	Common issues	53
5.4	Service	54
6	Returns	55
6.1	Removal and return instructions	55
6.2	Disposal (end of lifetime)	55
	Parameter index	57

1 Introduction

1.1 Scope of this manual

This manual covers the **EL-FLOW® Prestige** series mass flow meters/controllers for gases. This manual includes product information, installation instructions, operation, maintenance and troubleshooting tips.



1.2 Intended use

EL-FLOW® Prestige instruments are designed to accurately measure and/or control gas flow rates of a specified gas at the conditions stated on the serial number label. The gas in the pressurized system in which the instrument is mounted has to be clean and dry. The instruments are suited for general purpose indoor (dry) applications, like laboratories and machine enclosures. The instruments can be used for either (fast) switching gas flow or for controlling a constant flow rate (mass flow controllers only).



The wetted materials incorporated in the EL-FLOW® Prestige are compatible with media and conditions (e.g. pressure, temperature) as specified at ordering time. If you are planning to use the product (including any third party components supplied by Bronkhorst, such as pumps or valves) with other media and/or other conditions, always check the wetted materials (including seals) for compatibility. See the technical specifications of the product and consult third party documentation (if applicable) to check the incorporated materials.

Responsibility for the use of the equipment with regard to suitability, intended use, cleaning and corrosion resistance of the applied materials against the processed media lies solely with the end user.

Where appropriate, this document recommends or prescribes safety measures to be taken with respect to media usage or working with the described equipment under the specified conditions. The end user is responsible for taking the necessary safety precautions and proper use of appropriate (personal) protective equipment, even if such is not explicitly recommended or required in this document.

The end user is considered to be familiar with the necessary safety precautions, and to comply with the appropriate protective measures as described in the Material Safety Data Sheets of the media to be used in the system (if applicable).

Bronkhorst High-Tech B.V. cannot be held liable for any damage resulting from improper or unsafe use, use for other than the intended purpose or use with other media and/or under other conditions than specified on the purchase order.

1.3 Product description

EL-FLOW® Prestige is the next generation of Bronkhorst® Mass Flow Meters/ Controllers using the latest, highly accurate, thermal by-pass sensor technology and featuring excellent control characteristics. Thanks to the advanced sensor technology in combination with a state-of-the-art printed circuit board, the instruments feature improved long-term stability as well as an unsurpassed temperature stability. Furthermore, due to a power efficient microprocessor, the power consumption of the instrument is reduced. The mass flow meters and controllers can be supplied in full scale ranges from 0,7 ml_n/min up to 100 l_n/min Air-equivalent at max. 64 or 100 bar (1000 or 1500 psi) pressure rating.

EL-FLOW® Prestige offers high flexibility due to the multi-gas/multi-range functionality. This function, now extended to 100 gases and mixtures thereof, is easily accessible via the FlowTune™ software or PLC; there is no need to disconnect the instrument from your system. For additional gas types the user can calculate accurate fluid properties for conversion by means of our free, online software tool FLUIDAT® on the Net. Users of **EL-FLOW® Prestige** instruments can rescale their instruments on site, saving time and money for dismounting and recalibration.

Numerous input/output options can be installed through the programmable 9-pin D-sub connector (from factory). In addition to the various analog signal options and the standard RS232 communication, there are such options as RS485 communication, digital frequency/pulse output, alarm output/reset, valve purge/close and analog valve output. Furthermore Bronkhorst offers various integrated fieldbus options: DeviceNet™, PROFIBUS DP, Modbus RTU/ASCII, EtherCAT®, PROFINET and FLOW-BUS.

1.3.1 EL-FLOW® Prestige PI

The **EL-FLOW® Prestige PI** (pressure insensitive) adds active pressure compensation to the already very accurate controlling characteristics, resulting in even more accurate flow measurement and control stability.

An innovative static compensation algorithm ('FLUIDAT On Board') uses the actual fluid temperature and pressure to calculate fluid properties in real time. Density, viscosity, thermal conductivity and heat capacity of the processed media change under the influence of pressure and temperature. The Fluidat On Board algorithm continuously recalculates these properties and uses them to adjust the gas flow.

Dynamic pressure compensation detects rapid and large pressure changes (caused, for instance, by operating multiple flow devices on the same fluid line, also called the Crosstalk Pressure Effect) and adjusts the control signal in such a way that the gas flow remains stable.

The **EL-FLOW® Prestige PI** is available with a choice from two different pressure sensors (up to 10 bar(g) and up to 100 bar(g)), both of which apply static compensation. The 10 bar type also uses dynamic compensation.



1.4 Documentation

The EL-FLOW® Prestige comes with all necessary documentation for basic operation and maintenance. Some parts of this manual refer to other documents, most of which can be downloaded from the Bronkhorst website. A calibration certificate for each ordered instrument is part of the scope of delivery.



The documentation listed in the following table is available on the **EL-FLOW® Prestige** product pages under www.bronkhorst.com/products

Type	Document name	Document no.
Manuals	Instruction Manual EL-FLOW® Prestige (this document)	9.17.084
	Quick Installation Guide EL-FLOW® Prestige	9.17.083
Technical documentation	Hook-up diagram Analog/RS232	9.16.119
	Hook-up diagram EtherNet/IP	9.16.215
	Hook-up diagram CANopen	9.16.217
	Hook-up diagram DeviceNet™	9.16.122
	Hook-up diagram EtherCAT®	9.16.124
	Hook-up diagram FLOW-BUS	9.16.120
	Hook-up diagram Modbus ASCII / RTU	9.16.123
	Hook-up diagram Modbus TCP	9.16.234
	Hook-up diagram PROFIBUS DP	9.16.121
	Hook-up diagram PROFINET	9.16.147
	Hook-up diagram custom bus & I/O configurations	9.16.118
	Dimensional drawing	model specific



The documentation listed in the following table can be downloaded from www.bronkhorst.com/downloads

Type	Document	Document no.
General documentation	EU Declaration of Conformity	9.06.021
Manuals	Manual EtherNet/IP	9.17.132
	Manual CANopen interface	9.17.131
	Manual DeviceNet™ interface	9.17.026
	Manual EtherCAT® interface	9.17.063
	Manual FLOW-BUS interface	9.17.024
	Manual Modbus interface ASCII / RTU / TCP	9.17.035
	Manual PROFIBUS DP interface	9.17.025
	Manual PROFINET interface	9.17.095
Manual RS232 interface	9.17.027	

1.5 Model key

The model key on the serial number label contains information about the technical properties of the instrument as ordered. The actual properties of your instrument can be retrieved from the diagram below.

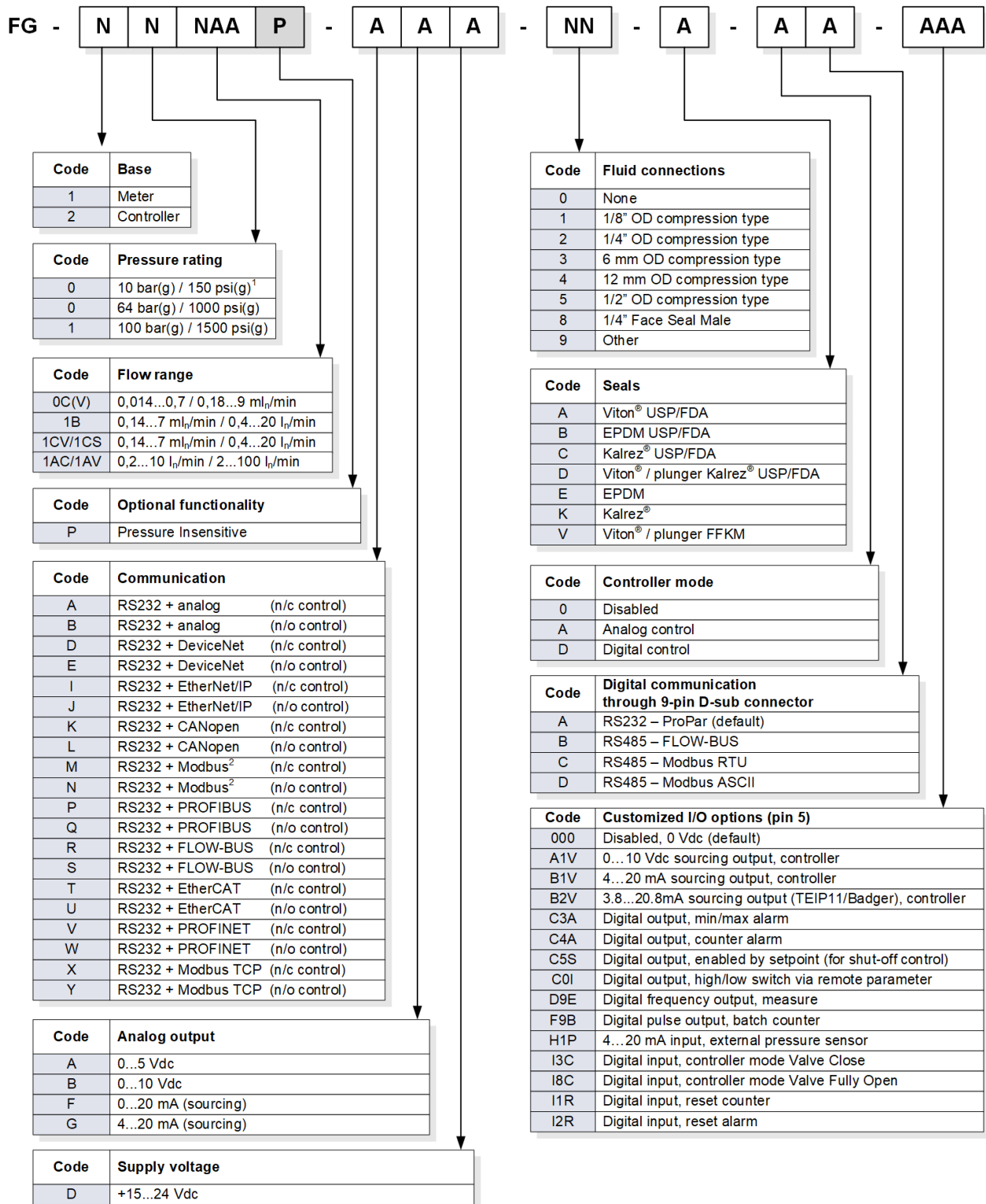

1) for CVP, CS and CSP models
2) default Modbus RTU, optional Modbus ASCII



See section [Customized I/O options \(pin 5\)](#) for more information about the pin-5 configuration options.

2 Starting up

2.1 Functional properties

Before installing the EL-FLOW® Prestige, check the serial number label on the rear side of the instrument to see if the functional properties match your requirements:

- Flow rate
- Media to be used in the instrument
- Input and output signal (see also section [Electrical connection](#))
- Upstream and downstream pressure(s)
- Operating temperature
- Valve type (NC = Normally Closed, NO = Normally Open)

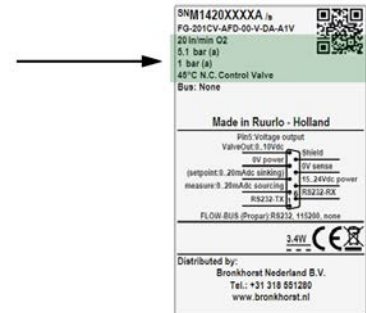

2.2 Operating conditions

Test pressure



Bronkhorst® instruments are pressure tested to at least 1.5 times the specified operating pressure and outboard leak tested to at least $2 * 10^{-9}$ mbar l/s Helium.



- The test pressure is specified on the device with a red label; if this label is missing or if the test pressure is insufficient, the device must not be used and should be returned to the factory.
- Before installation, make sure that the pressure rating is within the limits of the normal process conditions and that the tested pressure is in accordance with the safety factor of your application.
- Disassembling the device and/or replacing parts will invalidate the test pressure and leak test specification.

Sealing material compatibility



The EL-FLOW® Prestige is fitted with specific sealing material(s), compatible with the media specified at ordering time. See section [Sealing material compatibility](#) for a compatibility list for the most commonly used media.

Rapid gas decompression / explosive decompression



For instruments used above 10 barg:
Bronkhorst recommends a maximum decompression rate of 70 bar/min, according NACE TM0297.
Exceeding this rate can have negative influence on the lifetime of the sealing materials.

Ambient conditions

EL-FLOW® Prestige instruments are suitable for use in conditions between -10 and 70 °C and relative humidity of 10 to 90 % RH, unless specified otherwise. Please note that EL-FLOW® Prestige instruments have an ingress protection of IP-40, implying that the housing and electrical connection do not offer any protection against moist environments.



Make sure that process gases do not condensate in the instrument due to (changing) environmental conditions, condensed process fluids may seriously harm the instrument's functionality! E.g. do not use moist air as process gas at low temperatures.

2.3 Mounting



For optimal performance, observe the following guidelines:

- Preferably, mount the EL-FLOW® Prestige in an upright position, especially if the operating pressure is higher than 10 bar.
- If the instrument is mounted in a position where the flow is directed upwards or downwards, [adjusting the zero point](#) is recommended.
- Avoid installation in close proximity of mechanical vibration and/or heat sources.
- Use the equipment in an environment with a stable ambient pressure and temperature.



For stable fixation, the bottom of the instrument base is fitted with mounting holes. See the dimensional drawing for the exact locations.

2.4 Piping requirements

For reliable performance, make sure the fluid stream is uncontaminated. If necessary, use filters to assure a moisture, oil and particle free gas stream (recommended pore size: 5 µm). If back flow can occur, the use of a downstream filter and check valve is also recommended. Select a suitable filter size, to avoid a too high pressure drop.



- Use piping or tubing that is suitable for the operating conditions of the application (media, maximum temperature, maximum operating pressure).
- Do not install small diameter piping/tubing on high flow rates and avoid abrupt angles or other disturbances within a distance of 10 times the (inside) pipe diameter from the inlet or outlet of the device.
- Do not install pressure regulators within a distance of 25 times the (inside) pipe diameter from a controlling instrument.

2.5 Fluid connection

- Install the EL-FLOW® Prestige in the process line, in accordance with the direction of the FLOW arrow on the base of the instrument.
- Tighten connections according to the instructions of the supplier of the fittings. The use of Swagelok RS-type stainless steel adapters is recommended.



Check the fluid system for leaks before applying full operating pressure, especially when using hazardous media (e.g. toxic or flammable).

2.6 Electrical connection

Electrical connections must be made with standard cables or according to the applicable hook-up diagram (see section [Documentation](#)). The factory installed 9-pin D-sub settings are indicated on the serial number label. Make sure that the power supply is suitable for the power ratings as indicated on the serial number label, and that double or reinforced insulation is used for the power supply cabling.

EL-FLOW® Prestige instruments are powered with +15...+24 Vdc, depending on the fieldbus system (if applicable).

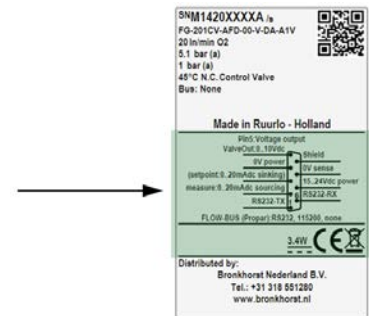

To comply with **IEC61010-1** requirements, limit the circuit current by using a limited-energy power source. A National Electrical Code (**NEC**) **Class 2** power source must be used that complies with **IEC 60950-1** (Limited Energy Circuit). As an alternative, the unit shall be supplied by a power source with reinforced insulation to mains in conjunction with a fuse in accordance with **UL248**. The fuse shall be rated max. 3 A and must be installed in the 15...24 Vdc power supply to the device in order to limit the available current.



Never power the instrument simultaneously from **two different power sources** (e.g. fieldbus and Plug-in Power Supply). Doing so will damage the printed circuit board irreparably.



The device described in this document contains electronic components that are susceptible to **electrostatic discharge**. In order to prevent damage, proper handling procedures must be followed during installation, (dis)connecting and removing the electronics.

The device carries the CE-mark and is **compliant with the concerning EMC requirements**. However, EMC requirements can only be met using appropriate cables and connector/gland assemblies. Bronkhorst recommends the use of their standard cables. These cables have the right connectors and loose ends (if any) are marked to help prevent wrong connection. When using other cables, cable wire diameters must be sufficient to carry the supply current, and voltage loss must be kept as low as possible. When in doubt, contact your Bronkhorst representative.

When connecting the product to other devices, be sure that the integrity of the shielding is not affected; **always use shielded cabling for signals and communication and do not use unshielded wire terminals**.

2.7 Analog / digital communication

2.7.1 Analog / local communication



If the instrument has a FLOW-BUS, Modbus or DeviceNet™ interface and is configured for digital communication, the 9-pin D-sub connector is protected by a dust cover. To gain access to the analog/local interface, the dust cover can be removed by pushing its lower end.



Use a loose-end cable with a 9-pin D-sub female connector on the instrument side (art. no. 7.03.004, 7.03.536 or 7.03.537) and refer to the hook-up diagram for analog operation to connect the required signals.



2.7.2 Digital RS232 communication

Digital operation over RS232 can be established when using the setup shown here or using a Bronkhorst® E-8000 readout/control unit. See section [Basic RS232 operation](#) for more cabling examples. Connecting the instrument with an RS232 cable or an RS232 cable with an RS232 to USB converter to a PC enables the use of the (free) Bronkhorst® FlowWare software for Windows, such as FlowDDE and FlowPlot. Make sure that the serial number label indicates RS232 settings for the 9-pin D-sub connector and apply the proper baud rate settings. If the instrument is not set for RS232 communication, please refer to [Basic RS232 operation](#) for switching to RS232 communication settings via the 'Configuration Mode'.

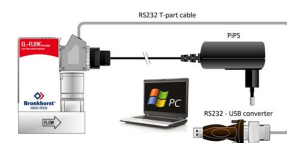

A PiPS (Plug-in Power Supply, article no. 7.03.422) is available to power a single instrument and can be used instead of the DB9 loose-end cable, as shown in the example above. Detailed information can be found in the **PiPS manual** (document no. 9.17.055) which can be downloaded from the **Accessories and software** section on the Bronkhorst® product pages (www.bronkhorst.com/products)

2.7.3 Digital RS485 / fieldbus communication

With digital operation over RS485 or Ethernet a bus system with multiple instruments can be set up:

- For RS485 FLOW-BUS or Modbus operation over the 9-pin D-sub connector or via an additional fieldbus driver (if installed), see section [Basic RS485 operation \(FLOW-BUS/Modbus\)](#).
- For operation via other additional fieldbus systems (e.g. DeviceNet™, EtherCAT®), refer to section [Other fieldbus configurations](#) or the specific fieldbus manual.

2.8 Micro switch operation

Using the two colored LEDs and the micro switch on the **EL-FLOW® Prestige**, several actions can be monitored and started. The green LED is used for status indication. The red LED is used for errors, warnings and messages. The switch can be used to start several actions, such as auto-zero, restoring factory settings and bus initialization actions, if applicable.

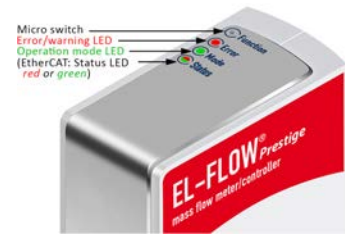

- See section [Adjusting zero point](#) for background information about and instructions for zeroing.
- See section [Micro switch functions](#) for a comprehensive description of the micro switch functionality.



The micro switch on top of the **EL-FLOW® Prestige** can be operated with a thin, metal or hard plastic pin, e.g. the end of a paperclip.

2.9 Powering up and powering down



- It is recommended to turn on power before applying fluid pressure and to switch off power only after relieving fluid pressure.
- For best performance, allow the device to warm up and stabilize for at least 30 minutes before starting measurement and/or control. This may be done with or without media flow.



When applying pressure, avoid pressure shocks and bring the fluid system gradually up to the level of the specified operating conditions; open the fluid supply gently.

2.10 First use



In systems for use with corrosive or reactive media, purging for at least 30 minutes with a dry, inert gas (like Nitrogen or Argon) is absolutely necessary before use. After use with corrosive, reactive or hazardous media (e.g. toxic or flammable), purging is also necessary before the fluid system is exposed to air.



The very first time the instrument is used, adjusting the zero point is recommended. See [Adjusting zero point](#) for background information and instructions.

2.11 Calibration

The EL-FLOW® Prestige is factory calibrated. Periodical inspection, recalibration or verification of the accuracy may be subject to individual requirements of the end user.

Bronkhorst certifies that the instrument meets the rated accuracy. Calibration has been performed using measurement standards traceable to the Dutch Metrology Institute (VSL).



Note that the calibration only applies to the primary measurement/control function of the instrument; secondary outputs (like temperature and pressure) are outside the calibration scope.

2.12 Maintenance

The EL-FLOW® Prestige needs no regular maintenance if operated properly, with clean media, compatible with the wetted materials, avoiding pressure and thermal shocks and vibrations. Units may be purged with a clean, dry and inert gas.

In case of severe contamination, cleaning the inside of the device may be required. After cleaning, recalibration of the instrument is recommended.



Inexpertly servicing instruments can lead to serious personal injury and/or damage to the instrument or the system it is used in. Servicing must therefore be performed by trained and qualified personnel. Contact your Bronkhorst representative for information about cleaning and calibration. Bronkhorst has a trained staff available.

3 Basic operation

3.1 Mass flow measurement and control

After correct installation of the **EL-FLOW® Prestige** Mass Flow Meter (MFM) or Mass Flow Controller (MFC) and when all safety precautions have been taken into account the instrument can immediately be used for measuring/ controlling the required flow rate in the system by means of the selected communication interface(s).

Here are some general guidelines for mass flow measurement/control:



EL-FLOW® Prestige MFMs/MFCs are most accurate at the specified inlet/outlet pressure, temperature and process gas conditions, however the instrument will function properly in a wide range of varying conditions. It is strongly advised to use the FlowTune™ software available with the instrument to set the correct process conditions if the actual process conditions differ from the conditions for which the instrument is set (see further).

Although **EL-FLOW® Prestige** MFMs/MFCs have excellent temperature stability, the best accuracy is achieved when temperature differences across the instruments are avoided; make sure that the gas temperature equals the ambient temperature and mount the instruments on a rigid (heat conducting) surface.

Regular **EL-FLOW® Prestige** MFCs handle pressure shocks in the system well, but are not insensitive to pressure fluctuations. For optimum control stability, provide a stable (pressure controlled) inlet pressure with sufficient buffer volume between the pressure regulator and the MFC and avoid installing multiple MFCs or other control valves in close proximity to another with small volume piping in between.

EL-FLOW® Prestige PI instruments (see [EL-FLOW® Prestige PI](#)) and instruments with **I/O option H1P** enabled (see [Customized I/O options \(pin 5\)](#)) automatically and continuously adjust the flow rate, based on the actual pressure measured by the built-in or external pressure sensor respectively.

When an MFC (either with normally closed (NC) or normally open (NO) valve) is hooked-up, the control valve stays closed when no setpoint is given. When the MFC receives a setpoint from the active setpoint source, the internal PID controller will immediately open the control valve until the required flow rate is achieved and it will maintain that flow rate until another setpoint is given.

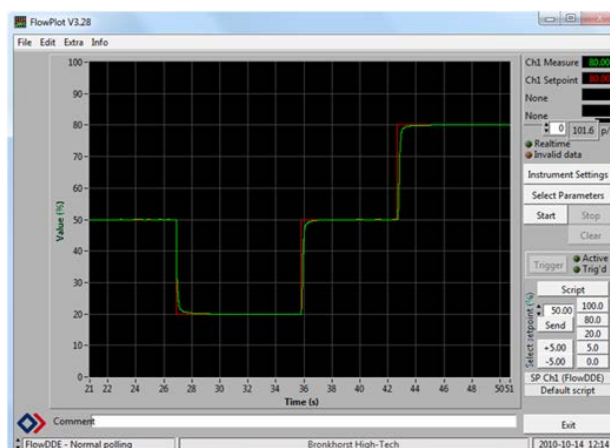

3.1.1 Changing fluid set, range or operating conditions

EL-FLOW® Prestige instruments provide Multi Fluid/Multi Range functionality (MFMR). With this functionality, the properties of a selection of 100 pre-installed gases or any mixture thereof can be used to reconfigure the instrument.

MFMR enabled instruments are calibrated ex factory for a number of standard measuring ranges, which can be configured for use with different fluids. Defining fluids and ranges and selecting the active fluid can be done via RS-232 with FlowTune™.

FlowTune™ provides the following key functionality:

- Definition and storage of up to eight different fluids in the instrument
- Storing fluid properties for any gas
- Changing inlet- and/or outlet pressure based on actual process conditions
- Re-ranging the full scale (FS) flow rate within the instrument's supported flow range
- Changing control speed per fluid set for faster or slower (smoother) flow control

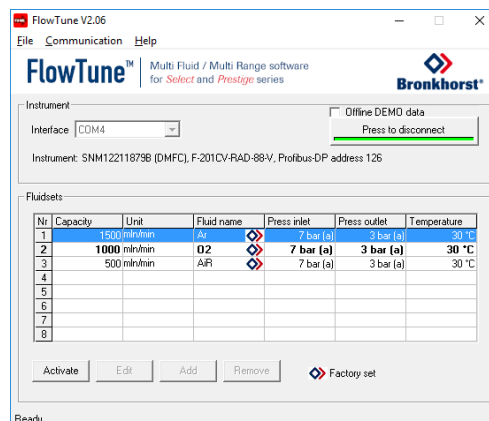

MFMR functionality is available for the full temperature and pressure range of the instrument. FlowTune™ checks the changes for the following limitations:

- Rangeability of the flow sensor for the selected fluid
- Rangeability of the control valve for the selected fluid
- Accuracy indication for the given flow range
- Compatibility of selected gases with the used sealing materials (see [Sealing material compatibility](#))
- Limitations to the operating conditions

After all limitation checks are passed, the entered properties are stored in the instrument, including the required controller settings. When switching to another fluid set, controller settings are automatically adjusted to the new process conditions, so there is no need to change PID controller settings manually.



The FlowTune™ software and the associated documentation can be downloaded from the product pages on the Bronkhorst website: www.bronkhorst.com/products



Note regarding instruments with active pressure compensation:

For **EL-FLOW® Prestige PI** (see [EL-FLOW® Prestige PI](#)) instruments and instruments with **I/O option H1P** enabled (see [Customized I/O options \(pin 5\)](#)) the inlet pressure entered in FlowTune is used only for flow range/capacity calculations (see [Advanced fluid set parameters](#)).



To connect with FlowTune™, use RS232 communication via the 9-pin D-sub connector. In case a connection cannot be established, use the power-up functionality of the [multifunctional switch](#) to switch to configuration mode and enable RS232 communication.

After configuring the required parameters, remember to return the instrument to the original communication mode.

It is advised to use FlowTune™ only in a non-operational environment. FlowTune™ will force the instrument to [Valve Safe State](#) as soon as the connection is made. Be sure to close communication between FlowTune™ and the instrument properly, to restore the normal operating mode.

Using custom fluids or fluid properties

With FlowTune™ fixed fluid properties for any gas or mixture can be stored in the instrument (density, heat capacity, thermal conductivity and dynamic viscosity). Although custom fluid data can be used, Bronkhorst advises to use the FLUIDAT® on the Net website for calculation of fluid properties at the actual process conditions. FLUIDAT® is a collection of routines to calculate physical properties of gases and liquids. These routines are made available at the FLUIDAT® on the Net website.



FLUIDAT® on the Net can be accessed on www.fluidat.com. You can try out FLUIDAT® on the Net with a limited number of fluids. Free registration on the FLUIDAT® website gives access to all available fluids and functionality.

3.1.2 Valve Safe State

When a controlling instrument is not powered or cannot communicate with the fieldbus network (if applicable), the control valve automatically returns to its default state (also called Safe State), which is closed for a 'normally closed' valve (n/c) and fully open for a 'normally open' valve (n/o). Taking into account the typical process conditions under which the instrument is used (such as the processed media and ambient conditions; see also [Intended use](#)), the default state is generally considered safe.

Check the serial number label or the technical specifications to see which valve type is used on your instrument (if applicable).

3.2 Communication interfaces

Numerous input/output options can be installed on **EL-FLOW® Prestige** instruments via both the 9-pin D-sub connector on the side of the instrument and the optional fieldbus connector on top of the instrument.

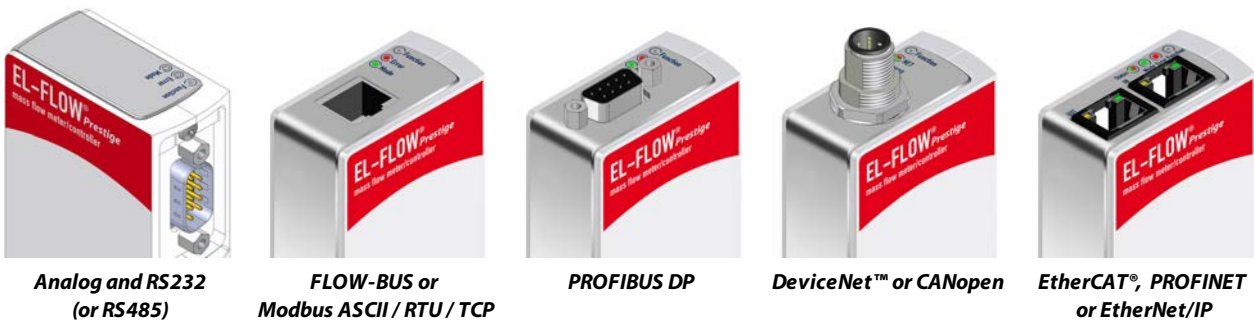

The standard 9-pin D-sub connector provides the following communication interfaces:

- Analog (0...5 Vdc; 0...10 Vdc; 0...20 mA or 4...20 mA)
- Digital RS-232 ([ProPar](#)) or RS-485 (FLOW-BUS or Modbus)

Additionally, the instrument can be provided with one of the following optional digital fieldbus interfaces:

- FLOW-BUS
- Modbus (ASCII / RTU / TCP)
- PROFIBUS DP
- EtherNet/IP
- CANopen
- DeviceNet™
- EtherCAT®
- PROFINET

The default communication protocol of the instrument (analog, digital RS-232 or fieldbus) is specified at ordering time.

3.2.1 Using multiple interfaces

The analog interface is always present on **EL-FLOW® Prestige** instruments. An interface to any available field bus is optional. Operation via analog interface, RS232/RS485 (side connector) and an optional fieldbus (top connector) can be performed at the same time. When using multiple interfaces, reading of parameters can be done simultaneously. When changing a parameter value, the last value sent by any of the interfaces will be valid.

Control mode

A controller setpoint is accepted from either the analog or digital interface, but not both. Analog or digital operation is selected at ordering time and is indicated on the serial number label. The inactive setpoint source is indicated between brackets (see example below). The parameter *Control Mode* indicates from which source a controller setpoint is accepted: analog or digital. See section [Special parameters](#) for more information regarding the *Control Mode* parameter.

Factory communication settings

The factory selected communication and side connector pinning settings are indicated on the serial number label. See example below for a description of the communication information:

1. [Model key](#)
2. Fieldbus (top connector) (example: none)
3. [Customized I/O setting \(pin 5\)](#)
4. Analog interface (pin 2, 3) (example: inactive setpoint source, measure always available)
5. Digital interface (pin 1, 6) (example: RS232, active setpoint source)
6. Side connector digital interface settings (protocol, medium, baud rate, parity) (example: FLOW-BUS (ProPar) communication over RS232 interface with baud rate 115200 Baud and no parity)

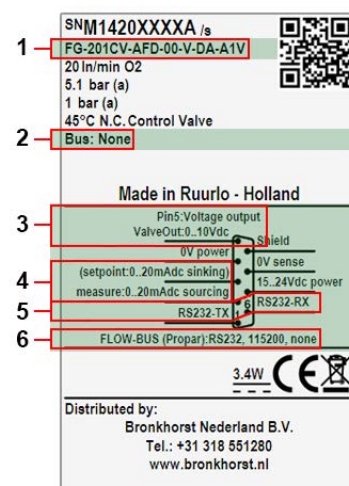

3.3 Analog operation

The following analog signals are available for each instrument through the 9-pin D-sub side connector:

- Measured value (analog output): pin 2
- Setpoint (analog input/setpoint): pin 3

The factory selected analog interface (0...5 Vdc; 0...10 Vdc; 0...20 mA or 4...20 mA) can be found in the [model key](#) of the instrument and in the pin description on the serial number label.

Pin 5 is used for customized I/O configurations. By default it is disabled and pulled down to 0 Vdc. The factory selected pin 5 configuration can be found in the [model key](#) and the pin description on the serial number label. See also section [Customized I/O options \(pin 5\)](#).



When operating the instrument through the analog interface it is possible to connect the instrument simultaneously to RS232 for reading/changing parameters (e.g. settings or fluid selection).

3.3.1 Cabling

Use a loose-end cable with a 9-pin D-sub female connector on the instrument side (art. no. 7.03.004, 7.03.536 or 7.03.537) and refer to the hook-up diagram for analog operation to connect the required signals.



3.4 Basic RS232 operation

Digital RS232 (or bus) operation adds a lot of extra features to the instruments compared to analog operation, such as:

- Multi gas / multi range functionality; up to eight selectable and customizable fluids ([Fluid set](#))
- Direct reading with a readout/control module or host computer
- Device identification and diagnostics ([Device identification](#))
- Adjustable minimum and maximum alarm limits ([Alarms](#))
- (Batch) counter ([Counter](#))

Each instrument process is controlled (internally) by specific parameters. The instrument parameter values are accessible through the available digital interfaces to influence the instrument behavior. In this section it is explained how to operate an instrument using RS232 communication.



Make sure that the serial number label indicates RS232 settings for the 9-pin D-sub connector and apply the proper Baud rate settings. If the instrument is not set for RS232 communication, use the micro switch on top of the instrument to overrule the custom settings and switch to RS232 communication settings: press and hold the micro switch at power-up and wait (12... 16 sec) until both ● green and ● red LEDs flash (0.2 sec on, 0.2 sec off). Release the switch to activate the 'Configuration Mode'. In the 'Configuration Mode' the bus type and baud rate for the 9-pin D-sub side connector are set to RS232 FLOW-BUS (ProPar) at 38400 Baud. The 'Configuration Mode' remains active after power down. Use the same procedure to deactivate the 'Configuration Mode'.

3.4.1 Cabling

3.4.1.1 RS232 communication

Using a Windows computer, the instrument can be monitored and operated via RS-232. For operation, the free Bronkhorst FlowWare tools can be used, providing a comprehensive user interface to the digital instrument functions.

This example uses the following components:

- EL-FLOW® Prestige
- RS-232 T-part cable (art no. 7.03.366)
- RS-232-USB converter (art no. 9.09.122)
- Windows computer (for readout and control)
- Plug-in Power Supply (PiPS, art no. 7.03.422)

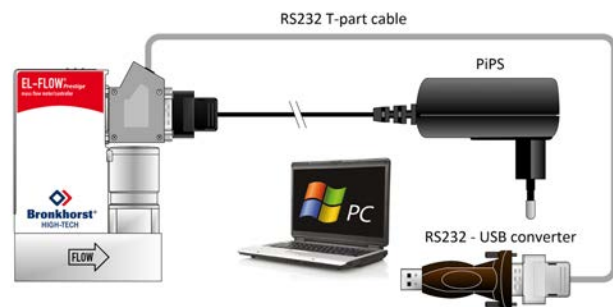

Connect the T-part cable with the 9-pin D-sub connector on the side of the instrument and use the RS-232/USB converter to connect the other end of the cable with a free USB port of the computer.



For communication with a **PLC or other** controlling device, a 9-pin D-sub cable with a loose end (part no. 7.03.004, 7.03.536 or 7.03.537) can be used. Consult the **RS-232 hook-up diagram** to connect the required signals.



For RS-232 communication at baud rates up to 38400 Baud the maximum allowable cable length is 10 m. For higher baud rates, use a maximum cable length of 3 m.



- For more information about communication through the RS-232 interface, consult the **RS-232 manual** (document no. 9.17.027).
- The FlowWare tools and accompanying documentation can be downloaded from the **Accessories and software** section on the Bronkhorst® product pages (www.bronkhorst.com/products).

3.4.1.2 RS232 communication powered by fieldbus

The instrument can be connected to a fieldbus system with the optional fieldbus connector on top. At the same time, RS-232 communication with a Windows computer is possible through the 9-pin D-sub connector on the side of the instrument.

This example uses the following components:

- EL-FLOW® Prestige with DeviceNet™ interface
- DeviceNet™ M12 cable (art no. 7.03.323)
- DeviceNet™ M12 Y adapter (art no. 7.03.319)
- RS-232 cable (art no. 7.03.367)
- RS-232-USB converter (art no. 9.09.122)
- Windows computer (for readout and control)

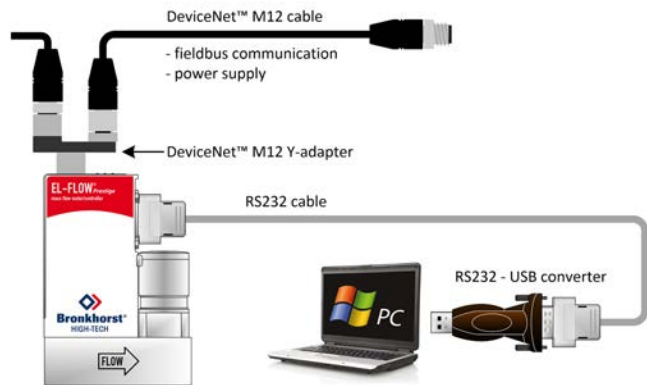

Note that the used fieldbus components in this example are specific to DeviceNet™. For connecting with other fieldbus systems, other cables and adapters are needed.



Always check the total power consumption of your instruments before connecting them to a fieldbus system. Do not exceed the maximum power of the power supply unit.



For all available fieldbus types except PROFIBUS DP, the fieldbus connection on is used to power and operate the instrument. For PROFIBUS DP, the instrument needs to be powered through the 9-pin D-sub connector on the side of the instrument as shown in [RS232 communication](#).



Consult the according [fieldbus manual](#) for more information about setting up a fieldbus network with Bronkhorst® instruments.
If you need assistance with setting up a fieldbus system, contact your Bronkhorst representative for information.

3.4.1.3 E-8000 power supply, readout and control

Using an E-8000 module, instruments can be powered (100...240 Vac) and operated via RS-232. Most digital parameters and functions are accessible via the display interface and the control buttons.

This example uses the following components:

- 2x EL-FLOW® Prestige
- 2x RS-232/power supply cable (art no. 7.03.016/7.03.538/7.03.539)
- E-8000 power supply, readout and control module

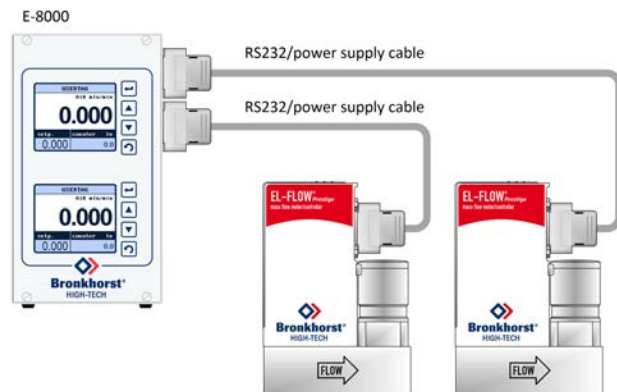

Consult the **E-8000 manual** (document 9.17.076) for more information. This manual can be downloaded from the **Accessories and software** section on the Bronkhorst® product pages (www.bronkhorst.com/products).

3.4.1.4 BRIGHT readout and control

Most digital parameters and functions are accessible via the display interface and control buttons of a BRIGHT readout and control module (type B1 or B2). When a BRIGHT module is installed, no other RS-232 connection can be established with the instrument.

This example uses the following components:

- EL-FLOW® Prestige
- BRIGHT readout and control module
- Plug-in Power Supply (PIPS, art no. 7.03.422)



Use the 9-pin D-sub connector on the side of the instrument to plug in the T-part that comes with the BRIGHT module.



Consult the **BRIGHT manual** (document 9.17.048) for more information. This manual can be downloaded from the **Accessories and software** section on the Bronkhorst® product pages (www.bronkhorst.com/products).

3.4.2 FlowDDE

Digital Bronkhorst® instruments can be operated via RS-232 using the Bronkhorst® FlowDDE server application. Dynamic Data Exchange (DDE) provides a basic level of inter process communication between Windows applications. Together with a client application, either self-made or with a third party SCADA program, it is possible to create an easy way of data exchange between the flow meter/controller and a Windows application. For instance, a cell in a Microsoft Excel spreadsheet can be linked to the measured value of an instrument; FlowDDE updates the cell automatically when the measured value changes.

FlowDDE uses specific parameter numbers for communicating with the instrument. A DDE parameter number is a unique number in a special FlowDDE instruments/parameter database and not the same as the parameter number from the process on an instrument. FlowDDE translates the node-address and process number to a channel number.

DDE-client applications communicate with the FlowDDE server by using DDE messages. Before messages can be exchanged, a DDE link has to be made. A DDE link consists of three parts: the server, the topic and an item. For separation the characters '|' and '!' may be used, so a DDE link in e.g. Microsoft Excel becomes: Server|Topic|Item.

For standard instrument parameters and the FlowDDE server, these are:

- Server: FlowDDE or FlowDDE2
- Topic: 'C(X)' for channel number X
- Item: 'P(Y)' for parameter number Y

An example of a DDE link in a Microsoft Excel cell is =FlowDDE|C(1)!P(8) to read parameter 8 of channel 1.

When not using FlowDDE for communication with the instrument, parameters are addressed by:

- Node address of the instrument
- Process number on the instrument
- Parameter number on the instrument

See section [Basic parameters and properties](#) for more information about instrument parameters.

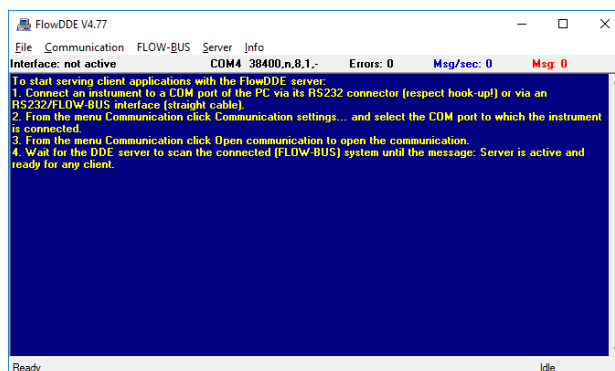

For more information about FlowDDE, including setting up a DDE link, consult the **FlowDDE Manual** (document no. 9.17.067) or the help file in the application.

3.4.3 Software (DDE applications)

Examples of free Bronkhorst® DDE client applications: FlowPlot and FlowView. Other software programs (third party) supporting DDE are for example MS-Office, LabVIEW, InTouch and Wizcon.

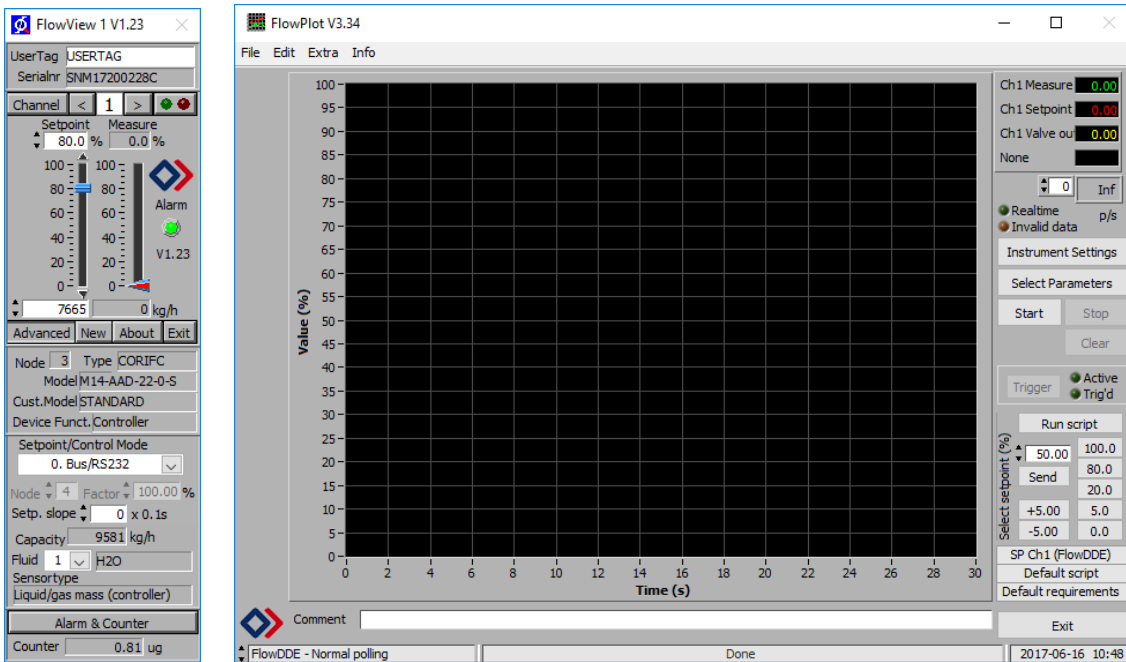

Bronkhorst® software applications 'FlowView' (left) and 'FlowPlot' (right)



FlowDDE and other Bronkhorst® applications are available on the support CD or can be downloaded from the product pages on the Bronkhorst website: www.bronkhorst.com/products

3.4.4 Baud rate setup

EL-FLOW® Prestige instruments support the following baud rates for RS232 communication. The factory selected baud rate is indicated on the serial number label. See section [Network configuration](#) for changing the baud rate settings for the instrument. The default baud rate for RS232 communication is 38400 Baud.

Mode:	Digital
Interface/medium:	RS232
Protocol:	FLOW-BUS (ProPar)
Baud rate:	9600 16200 38400 57600 115200 230400 460800
Node address:	3
Parity:	None



Make sure that the instrument's baud rate corresponds with the baud rate of the application the instrument is communicating with, otherwise no communication can be established.

For RS232 communication, the maximum cable length is 10 m for baud rates up to 38400 Baud. For higher baud rates, use cable lengths of maximum 3 m.



For more information regarding communication through an RS232 interface, see **document 9.17.027: RS232 interface with FLOW-BUS for digital instruments.**

3.5 Basic RS485 operation (FLOW-BUS/Modbus)

This section is limited to RS485 FLOW-BUS or Modbus communication. See section [Other fieldbus configurations](#) for communication through other fieldbus interfaces.

FLOW-BUS or Modbus communication is available if either the FLOW-BUS or Modbus RJ-45 connector on top of the instrument is present, or if the 9-pin D-sub side connector is set for FLOW-BUS or Modbus communication. The serial number label indicates the factory settings of the connector pinning.

FLOW-BUS

FLOW-BUS is a Bronkhorst® designed fieldbus, based on RS-485 technology, for digital communication between devices, offering the possibility of host-control by a Windows computer.

Characteristics:

- Baud rate 187500 (default) or 400000 Baud
- +15...24 Vdc supply voltage
- Easy installation and communication with other Bronkhorst® devices
- Automatic node search and bus optimization (gap fixing)
- RS-232 communication ([ProPar](#)) with Windows computer (local host)
- Connection of up to 120 instruments on a single bus
- Maximum bus length: 600 m



Consult **Instruction manual FLOW-BUS interface** (document no. 9.17.024) for more information about setting up a FLOW-BUS network.

Modbus

Modbus is a 3-wire, RS-485-based fieldbus communication system for parameter value exchange. In this system each instrument/device is equipped with a micro-controller for its own dedicated task. The instrument behaves as a slave, which means all communication (instructions and readout) is initiated by a master device on the Modbus system.

Characteristics:

- Baud rate selectable between 9600 and 256000 Baud (default: 19200 Baud)
- +15...24 Vdc supply voltage
- Connection of up to 247 instruments on a single bus
- Supports RTU and ASCII protocols



Consult **Instruction manual Modbus interface** (document no. 9.17.035) for more information about setting up a Modbus network.



More detailed information about Modbus can be found at **www.modbus.org** or any website of the (local) Modbus organization of your country (if available).

3.5.1 Cabling

This section shows cabling examples of some **EL-FLOW® Prestige** instruments in an RS485 fieldbus system. Note that many other fieldbus configurations are possible, contact your local sales representative for more information. Please check the total power consumption of your instruments and do not exceed the maximum power of the power supply.

FLOW-BUS setup

In the example below an E-8000 power supply/readout control unit with FLOW-BUS is connected to two **EL-FLOW® Prestige** instruments via the RJ-45 top-connector FLOW-BUS interface. In this example one instrument serves as a local host for RS232 communication with a Windows computer through the 9-pin D-sub connector on the side of the instrument. All other instruments on the FLOW-BUS network are also accessible via the local host. It is even possible to use multiple local host RS232/FLOW-BUS interfaces simultaneously.

The following components are used in this example:

- 2x EL-FLOW® Prestige
- 2x modular Y adapter cable (art. no. 7.03.241)
- 2x RJ-45 patch cable (art.no 7.03.238)
- RJ-45 begin terminator (art. no. 7.03.297)
- RJ-45 end terminator (art. no. 7.03.298)
- E-8000 power supply, readout and control module
- RS232 cable (art.no. 7.03.367)
- RS232-USB converter (art no. 9.09.122)
- Windows computer

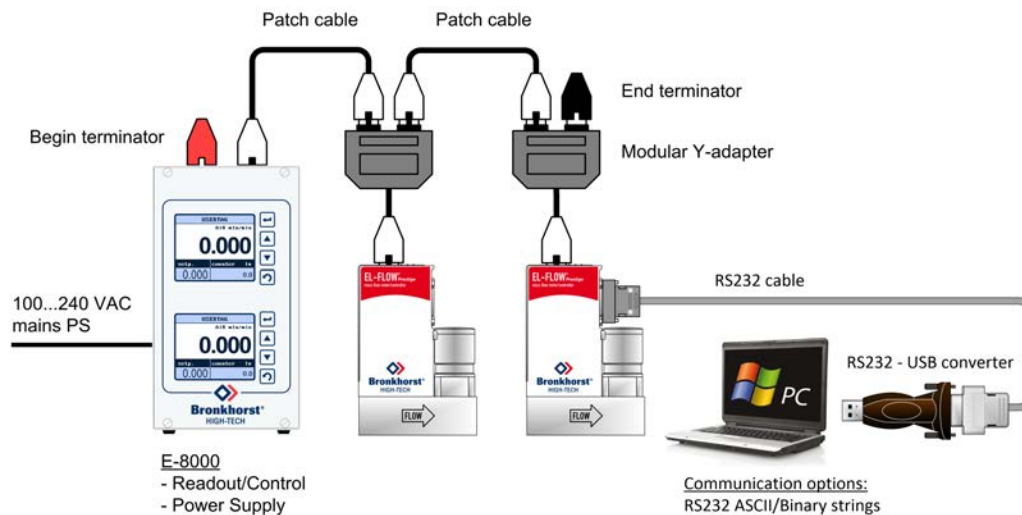

Power the instruments in a FLOW-BUS local-host system by hooking-up the power supply directly on the FLOW-BUS line and not by powering instruments through the 9-pin D-sub connector.

Modbus setup

In the example below the Modbus power supply is provided by an E-8000 module. The **EL-FLOW® Prestige** instruments are connected to the fieldbus network via RS485 cables with RJ-45 connector and a multiport connector. The RS485 - USB2.0 adapter can be used to connect the system to a Modbus master device.

The following components are used in this example:

- 3x EL-FLOW® Prestige
- 2x modular Y adapter cable (art. no. 7.03.241)
- 3x RJ-45 patch cable (art.no 7.03.238)
- RJ-45 begin terminator (art. no. 7.03.297)
- RJ-45 end terminator (art. no. 7.03.298)
- RJ-45 multiport connector (art. no. 7.03.299)
- E-8000 power supply module
- RS485 - USB2.0 adapter (art. no. 7.03.470)

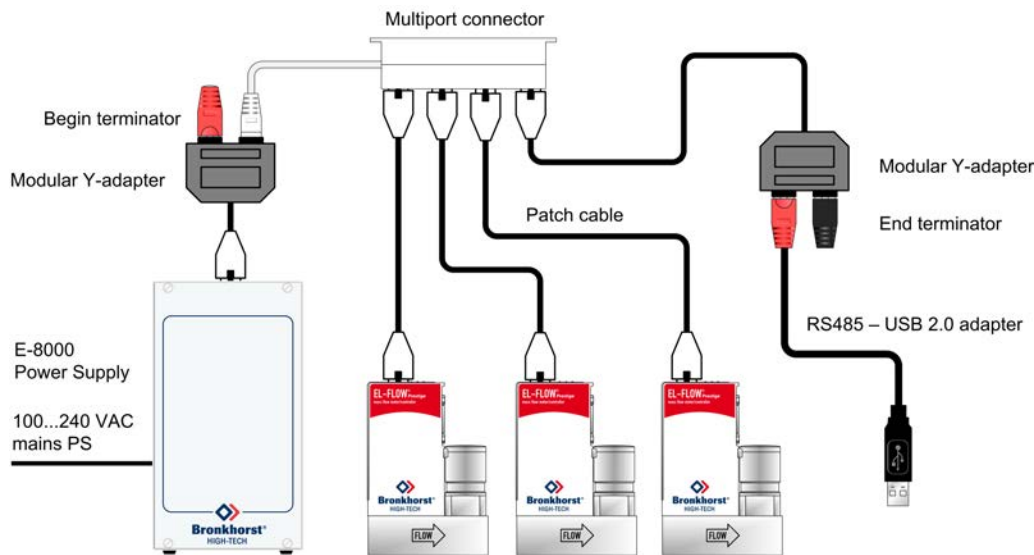

For supported power supply and communication options, refer to the **E-8000 manual** (document no. 9.17.076)

3.5.2 Software

When using a Windows computer to communicate with **EL-FLOW® Prestige** instruments, only the ProPar protocol (used by FLOW-BUS) is supported by Bronkhorst® software. When using Modbus operation, software from third parties, such as LabVIEW, ModScan or a Modbus PLC must be used to serve as Modbus master.



*Note: an instrument with 9-pin D-sub side connector set for RS485 FLOW-BUS or Modbus communication will not respond when connecting to an RS232 configuration. If the instrument is not set for RS232 communication, use the micro switch on top of the instrument to override the custom settings and switch to RS232 communication settings: press and hold the micro switch at power-up and wait (12... 16 sec) until both **green** and **red** LEDs flash (0.2 sec on, 0.2 sec off). Release the switch to activate the 'Configuration Mode'. In the 'Configuration Mode' the bus type and baud rate for the 9-pin D-sub side connector are set to RS232 FLOW-BUS (ProPar) at 38400 Baud. The 'Configuration Mode' remains active after power down. Use the same procedure to deactivate the 'Configuration Mode'.*

3.5.3 Baud rate, node address and parity setup

EL-FLOW® Prestige instruments are configured from factory as indicated on the serial number label. If there is a need of changing any of the specified RS485 settings, see the tables below for the supported configurations. The default selections are printed in boldface.

Mode:	Digital		
Interface/medium:	RS485		
Protocol:	FLOW-BUS	Modbus RTU	Modbus ASCII
Baud rate:	187500 400000	9600 19200 38400 56000 57600 115200 128000 256000	9600 19200 38400 56000 57600 115200 128000 256000
Node address:	3...125	1...247	1...247
Parity:	None	None; Even ; Odd	None; Even ; Odd

Changing RS485 settings of the RJ-45 top connector interface

In case the FLOW-BUS or Modbus RJ-45 field bus connector is used for bus communication, the node address can be easily set by using the rotary switches on the side of the instrument. Use the 'MSD' (Most Significant Digit) to set the 'tens' of the bus-address and the 'LSD' (least Significant Digit) to set the 'unit' of the bus-address (the example on the right reads '63'). Set the rotary switches to '00' for automatic installation. Refer to the corresponding field bus manual, **document 9.17.024** (FLOW-BUS) or **document 9.17.035** (Modbus) for more details.

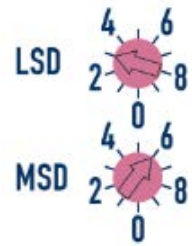

For changing the baud rate or parity settings use the RS232 interface to change the corresponding parameters (see section [Network configuration](#)).

Changing RS485 settings of the 9-pin D-sub side connector interface

In case the 9-pin D-sub side connector is set for RS485 communication, the baud rate or node address can be changed by using the micro switch or by changing the settings in the 'Configuration Mode'. Refer to **section 3.8** for changing node address and baud rate with the micro switch. Other communication parameters can be changed only in the 'Configuration Mode'. Activate the 'Configuration Mode' by pressing the micro switch at start-up according to the description in the previous. In 'Configuration Mode' the bus type and baud rate are set to RS232 FLOW-BUS (ProPar) at 38400 Baud. Change the appropriate parameters as described in [Network configuration](#). When finished, deactivate the 'Configuration Mode' using the same procedure. Now the instrument is ready to use in the desired configuration with the adjusted baud rate, node address or parity.



Any changes made to the instrument communication settings will **not** be restored after a factory reset.

3.6 Other fieldbus configurations

The following fieldbuses are optionally available for the **EL-FLOW® Prestige** instruments. For all mentioned fieldbus systems the **EL-FLOW® Prestige** instruments serve as slaves on the master/slave bus system. There is no mutual communication between slaves, only between master and slave.

PROFIBUS DP

PROFIBUS DP is a 2-wire, RS-485-based industrial data communication standard (fieldbus) which allows automation components (e.g. sensors, actuators and controllers) to exchange information.



Consult **Instruction manual PROFIBUS DP interface** (document no. 9.17.025) for more information about setting up a PROFIBUS DP network.

DeviceNet™

The DeviceNet™ interface offers a direct connection to a DeviceNet™ network, according to the mass flow controller profile specified by the ODVA. The Bronkhorst® DeviceNet™ instrument is a Group 2 Only Server device whose messages comply with the Controlled Area Network (CAN) 2.0A standard and with the DeviceNet™ protocol.



Consult **Instruction manual DeviceNet™ interface** (document no. 9.17.026) for more information about setting up a DeviceNet™ network.

EtherCAT®

Ethernet for Control Automation Technology (EtherCAT®) is an open high performance Ethernet based fieldbus system.



Consult **Instruction manual EtherCAT® interface** (document no. 9.17.063) for more information about setting up an EtherCAT® network.

PROFINET

The PROFINET interface is 100% Ethernet compatible and is used for data exchange between I/O controllers (PLC, etc.) and I/O devices (slaves, field devices). PROFINET uses the proven communication model and application view of PROFIBUS DP.



Consult **Instruction manual PROFINET interface** (document no. 9.17.095) for more information about setting up a PROFINET network.

3.6.1 Baud rate, node address and parity setup

In the table below for the supported configurations for PROFIBUS DP, DeviceNet™, EtherCAT® and PROFINET are shown. The default selections are printed in boldface.

Mode:	Digital			
	9-pin D-sub (female)	5-pin M12 (male)	2x RJ45 (in/out)	2x RJ45
Connector:	RS485	RS485	Ethernet	Ethernet
Interface/medium:	PROFIBUS DP	DeviceNet™	EtherCAT®	PROFINET
Protocol:	Autodetect (9600) (19200) (45450) (93750) (187500) (500000) (1500000) (3000000) (6000000) (12000000)	125000 250000 500000	100000000	100000000
Baud rate:	0...126	0..63	0 (n/a)	0 (n/a)
Node address:	Even	None	None	None
Parity:				

Changing PROFIBUS DP node address

The node address can be easily set by using the rotary switches on the side of the instrument. Use the 'MSD' (Most Significant Digit) to set the 'tens' of the bus-address and the 'LSD' (least Significant Digit) to set the 'unit' of the bus-address.

Changing DeviceNet™ node address and data rate

The node address and data rate can be easily set by using the rotary switches on the side of the instrument. Use the 'MSD' (Most Significant Digit) to set the 'tens' of the bus-address and the 'LSD' (least Significant Digit) to set the 'unit' of the bus-address. Set the 'MSD' rotary switch to 'P' to select programmable bus-address. For the data rate setting select '1' for 125000 Baud, '2' for 250000 Baud, '5' for 500000 Baud and 'P' for programmable data rate.

Changing EtherCAT® Second Address

EtherCAT® supports the use of a Second Address. Bronkhorst® instruments have 3 rotary switches, with which a Second Address can be set in the range of 0 – 4095 (0xFFF). This value of the rotary switches will be copied to the Configured Station Alias register (address 0x0012:0x0013) at instrument start-up.

3.7 LED indications

The following LED indicators are present on top of the instrument:

- **'Mode'** LED: green ● used for operation mode indication
- **'Error'** LED: red ● used for error/warning messages
- **'NET'** LED: green/red ●/● used for Network status (*DeviceNet™ only*)
- **'MOD'** LED: green/red ●/● used for Module status (*DeviceNet™ only*)
- **'Status'** LED: green/red ●/● used for status indication (*EtherCAT® and PROFINET only*)

Ethernet indicators

RJ-45 connection sockets on instruments with a EtherCAT® or PROFINET interface have two integrated LED indicators, with standard Ethernet functionality:

- Amber: Ethernet speed
- Green: Ethernet link/activity

The tables below list the different LED indications:

● Green		
Pattern	Time	Indication
off	continuous	Power-off or program not running
on	continuous	Normal operation mode
short flash	0.1 sec on, 2 sec off	Valve Safe State mode; there is no bus communication (PROFIBUS DP, DeviceNet™, EtherCAT® and PROFINET). Valves are in safe state. This LED indication is also active when the instrument is in 'Initialization Mode' (parameter <i>Init Reset</i> = 73)
blink	0.2 sec on, 0.2 sec off	Special function mode; the instrument is busy performing a special function (e.g. auto-zero or self-test)
long flash	2 sec on, 0.1 sec off	Configuration mode; the 9-pin D-sub (power) connector is set for RS232 communication (ProPar) at baud rate 38400

● Red		
Pattern	Time	Indication
off	continuous	No error
on	continuous	Critical error; the instrument needs servicing before it can be used
short flash	0.1 sec on, 2 sec off	FLOW-BUS Node occupied: re-install instrument PROFIBUS DP No data exchange between master and slave (automatic recovery) Modbus Data is being received or transmitted DeviceNet™ Minor communication error EtherCAT® Instrument is not in OP mode PROFINET No application relation established
blink	0.2 sec on, 0.2 sec off	FLOW-BUS Waiting for communication PROFIBUS DP Not used Modbus Not used DeviceNet™ No bus power EtherCAT® Not used PROFINET Not used
long flash	2 sec on, 0.1 sec off	FLOW-BUS Not used PROFIBUS DP Requested parameter not available Modbus Not used DeviceNet™ Serious communication error; manual intervention needed EtherCAT® Configuration error PROFINET Configuration error (e.g. a requested parameter is not available)

● Green and ● red (alternating)		
Pattern	Time	Indication
slow wink	1 sec on, 1 sec off	Alarm indication; minimum/maximum alarm, power-up alarm, limit reached or batch size reached
normal wink	0.2 sec on, 0.2 sec off	Wink mode; by sending a command to the <i>Wink</i> parameter, the instrument flashes its LEDs to indicate its physical location
fast wink	0.1 sec on, 0.1 sec off	Selected action started (after releasing the multifunctional switch)

DeviceNet™ LED indications

Specific LED indications are applicable to instruments with DeviceNet™ interface. Note: the 'NET' and 'MOD' LEDs are bi-colored LEDs (green/red). Refer to the DeviceNet™ manual, **document 9.17.026**, for more information.

EtherCAT® LED indications

Specific LED indications are applicable to instruments with EtherCAT® interface. Refer to the EtherCAT® manual, **document 9.17.063**, for more information.

PROFINET LED indications

Specific LED indications are applicable to instruments with PROFINET interface. Refer to the PROFINET manual, **document 9.17.095**, for more information.

3.8 Micro switch functions

Some special functions of the instrument can be started manually using the multifunctional switch near the indication LEDs. These functions are available in analog as well as in digital operation mode.



The micro switch on top of the EL-FLOW® Prestige can be operated with a thin metal or hard plastic pin, e.g. the end of a paperclip.

3.8.1 Normal operating functions

- In order to access these functions, press and hold the switch while the instrument is in normal operation mode (green LED glowing).
- As long as the switch is held, the LEDs show a repeating sequence of patterns, where each pattern indicates a function.
- All indications in this sequence are continuous.
- Each pattern is shown for a number of seconds; in the table below the column *Hold time* indicates the time frame within the sequence where the LEDs show the associated pattern.
- To start a function, release the switch when the LEDs show the pattern of the required function.



● (green)	● (red)	Hold time	Function
off	off	0...1 sec	No action
off	off	1...4 sec	1. In case of a min/max alarm: reset alarm 2. FLOW-BUS: Auto-install to bus - lets instrument obtain free node address if configured node address is occupied Note: min/max alarm (if any) has to be reset before auto install can be performed.
off	on	4...8 sec	Reset instrument; clear all warnings and error messages and restart the instrument
on	off	8...12 sec	Auto-zero; re-adjust the zero-point of the instrument (flow meters/controllers only)
on	on	12...16 sec	Enable FLASH mode for firmware update: <ul style="list-style-type: none"> • the instrument shuts down and both LEDs are switched off • at the next power-up, the instrument will be active again



See [Adjusting zero point](#) for background information and instructions on how to adjust the zero point of an instrument. Never perform a zeroing procedure before having taken notice of the instructions.

3.8.2 Power-up functions





- In order to access these functions, press and hold the switch while powering up the instrument.
- As long as the switch is held, the LEDs show a repeating sequence of patterns, where each pattern indicates a function.
- All indications in this sequence are flashing (0.2 sec on, 0.2 sec off).
- Each pattern is shown for a number of seconds; in the table below the column *Hold time* indicates the time frame within the sequence where the LEDs show the associated pattern.
- To start a function, release the switch when the LEDs show the pattern of the required function.

 (green)	 (red)	Hold time	Function
off	off	0...4 sec	No action
off	on	4...8 sec	Restore factory settings (except communication settings)
on	off	8...12 sec	FLOW-BUS Auto install to bus; let the instrument obtain a free node address from the FLOW-BUS system Other protocols No action
on	on	12...16 sec	Activate configuration mode <ul style="list-style-type: none"> • The 9-pin D-sub connector is set to RS-232 communication (ProPar) at baud rate 38400 • In configuration mode, the green LED blinks (2 seconds on, 0.1 second off) • Configuration mode remains active after powering-down and can be deactivated by selecting this function again at the next start-up

3.8.3 Control mode - readout/change

Reading control mode

- By briefly pressing the switch 2 times with intervals of up to 1 second in normal operation mode, the instrument shows its current control mode with a series of consecutive LED indication patterns.
- The number of flashes corresponds to the current value of parameter *Control Mode* (see [Special parameters](#)).





Step	Pattern	Indication
1.	Green  	number of flashes indicates the tens of the parameter value
2.	Red  	number of flashes indicates the units of the parameter value

Examples:

- for value 1 (control mode 'Analog input'), the green LED will flash 0 times and the red LED 1 time
- for value 22 (control mode 'Valve Safe State'), the green and red LED will each flash 2 times

Changing control mode

- By briefly pressing the switch 4 times with intervals of up to 1 second in normal operation mode, the instrument enters a state in which the control mode can be changed.
- This is done in 2 steps, each represented by a LED indication pattern (green or red; see table below).
- The number of flashes corresponds to the available values of parameter *Control Mode* (see [Special parameters](#)).
- At the start of each step, the according LEDs starts flashing fast (0.1 second on, 0.1 second off). By pressing and holding the switch, the associated action is started and the flashing slows (0.5 seconds on, 0.5 seconds off).

Step	Pattern	Maximum flash count	Action
1.	Green  	2	set tens of parameter value
2.	Red  	9	set units of parameter value

To execute a step, follow these instructions:

- Press and hold the switch (flashing slows)
- To select value 0 (zero), release the switch within 1 second, otherwise:
- Count the number of LED flashes
- Release the switch when the required value is reached
- In case you lose count, keep the switch pressed and wait until the flash count reaches its maximum and restarts

On completion of step 1, the instrument automatically advances to step 2. When both steps have been completed, the instrument returns to its normal operation mode.

If the switch is not pressed within 60 seconds after starting a step, all changes are canceled and the instrument returns to its normal operation mode.









Note that this procedure also sets the [default control mode](#) of the instrument (contrary to changing the control mode digitally).

3.8.4 Network settings - readout/change

Reading network settings

- By briefly pressing the switch 3 times with intervals of up to 1 second in normal operation mode, the instrument shows its current node address and baud rate with a series of consecutive LED indication patterns:

Step	Pattern	Indication
1.	Green  	number of flashes indicates the tens of the node address
2.	Red  	number of flashes indicates the units of the node address
3.	Green and red (simultaneous)  	number of flashes indicates the baud rate

Examples:

- for node address 35, the green LED will flash 3 times and the red LED 5 times
- for node address 116, the green LED will flash 11 times and the red LED 6 times





On DeviceNet™ the node address is called MAC ID.

The number of flashes for the baud rate indication is associated with the following baud rates:

Number of flashes (index)	Baud rate					
	FLOW-BUS	Modbus	PROFIBUS DP	DeviceNet™	EtherCAT®	PROFINET
0			automatically detected			
1	187500	9600	9600	125000	10000000	10000000
2	400000	19200	19200	250000		
3		38400	45450	500000		
4		56000	93750			
5		57600	187500			
6		115200	500000			
7		128000	1500000			
8		256000	3000000			
9			6000000			
10			12000000			

Changing network settings

- By briefly pressing the switch 5 times with intervals of up to 1 second in normal operation mode, the instrument enters a state in which the node address and baud rate can be changed (non-Ethernet based protocols only; for Ethernet based protocols (EtherCAT®, PROFINET), network parameters are configured by the fieldbus master and cannot be set on the instrument).
- Changing network parameters with the multifunctional switch is done in 3 steps, each represented by a LED indication pattern (see table below).
- At the start of each step, the according LED(s) start(s) flashing fast (0.1 second on, 0.1 second off). By pressing and holding the switch, the associated action is started and the flashing slows (0.5 seconds on, 0.5 seconds off).

Step	Pattern	Maximum flash count	Action
1.	Green 	12	set tens of node address
2.	Red 	9	set units of node address
3.	Green and red (simultaneous) 	10*	set baud rate index (number of flashes)

*) maximum count depends on the supported baud rates of the fieldbus. See the baud rate table above for supported baud rates and associated indexes.

To execute a step, follow these instructions:

- Press and hold the switch (flashing slows)
- To select value 0 (zero), release the switch within 1 second, otherwise:
- Count the number of LED flashes
- Release the switch as soon as the required value is reached
- In case you lose count, keep the switch pressed and wait until the flash count reaches its maximum and restarts

On completion of a step, the instrument automatically advances to the next step. When all required steps have been completed, the instrument returns to its normal operation mode.

If the switch is not pressed within 60 seconds after starting a step, all changes in the previous steps are cancelled and the instrument returns to its normal operation mode.

3.9 Basic parameters and properties

This section describes the most common parameters for digital communication with the instrument.



Digital parameters are most easily accessible via FlowPlot or FlowView software or a Bronkhorst® readout and control unit (E-8000 or BRIGHT).

3.9.1 General

This section describes the most commonly used parameters for digital operation of the EL-FLOW® Prestige. Descriptions are grouped by category in tables as shown below:

Type	Access	Range	FlowDDE	FLOW-BUS	Modbus
[type]	RW 	[x]...[y]	[DDE par]	[Pro]/[Par]	[address]/[register]



In this manual, parameter names are printed in italics (reverted to normal where embedded in italics, like in this tip).

Type

- Unsigned char 1 byte unsigned integer (0...255)
- Unsigned int 2 byte unsigned integer, MSB first (0...65535)
- Unsigned long 4 byte unsigned integer, MSB first (0...4294967295)
- Float 4 byte floating point, IEEE 32-bit single precision, MSB first
- Unsigned char [x] x byte array (text string)

Access

R	Parameter value can be read
W	Parameter value can be written
	Parameter is secured and only accepts values if parameter <i>Init Reset</i> is set to 'unlocked' first

Range

Some parameters only accept values within a certain range:

[x]	Minimum value of the range
[y]	Maximum value of the range

FlowDDE

Parameter number within FlowDDE

FLOW-BUS

Within the FLOW-BUS protocol (ProPar when using RS-232 communication), parameters are identified by a unique combination of a process number and a parameter number:

[Pro]	Process number
[Par]	Parameter number



Consult the **RS-232 manual** (document no. 9.17.027) for detailed information.

Modbus

In the Modbus protocol, parameters are accessed by specifying their unique decimal register number or corresponding PDU address (Protocol Data Unit). The PDU address is the hexadecimal translation of the register number minus 1, e.g. register number 1 corresponds to PDU address 0x0000, register number 11 corresponds to PDU address 0x000A:

[address]	Hexadecimal PDU address
[register]	Decimal register number

Modbus address blocks are two bytes big. Larger data types use up to 8 subsequent address blocks, resulting in a maximum variable length of 16 bytes. Values longer than the maximum length are truncated.

Other interface protocols

Consult the specific fieldbus manual for accessing parameters using fieldbus communication (see [Documentation](#)).

3.9.2 Measurement and control (basic)**Measure**

Type	Access	Range	FlowDDE	FLOW-BUS	Modbus
Unsigned int	R	0...41942 (65535*)	8	1/0	0x0020/33

This parameter indicates the flow metered by the instrument. The signal of 0...100% is presented in a range of 0...32000. The maximum measured value output is 131.07%, which translates to 41942.

A floating point pendant of the measured value is also available in the capacity unit for which the instrument was set; see section [Measurement and control \(advanced\)](#).



*In case the instrument is prepared for bi-directional measurement, the negative signals with an output range of -73.73...-0.003% are represented by the range of 41943...65535, whereas the positive signals 0...131.07% are still represented by the range of 0...41942. (FlowDDE converts the numbers to negative values automatically).

Setpoint

Type	Access	Range	FlowDDE	FLOW-BUS	Modbus
Unsigned int	RW	0...32000	9	1/1	0x0021/34

This parameter is used to set the required flow rate for the controller. The signals have the same range as *Measure*, but the setpoint is limited between 0 and 100% (0...32000).

A floating point pendant of the setpoint is also available in the capacity unit for which the instrument was set; see section [Measurement and control \(advanced\)](#).



To convert *Measure* and *Setpoint* to actual volume flows, use parameters *Capacity* and *Capacity Unit* (see [Fluid set](#))

3.9.2.1 Secondary outputs

Temperature

Type	Access	Range	FlowDDE	FLOW-BUS	Modbus
Float	R	-250...500	142	33/7	0xA138...0xA139/41273...41274

This parameter returns the internal temperature in the instrument housing in °C, which approximates the actual media temperature.

Pressure

Type	Access	Range	FlowDDE	FLOW-BUS	Modbus
Float	RW	0...3.4E+38	143	33/8	0xA140...0xA141/41281...41282

- For regular EL-FLOW® Prestige models, the default value of this parameter is equal to parameter *Inlet pressure*.
- For the EL-FLOW® Prestige PI (with an internal pressure sensor) and for regular models with an externally connected pressure sensor, this parameter returns the measured (inlet) pressure in bar(a).

3.9.3 Device identification

User Tag

Type	Access	Range	FlowDDE	FLOW-BUS	Modbus
Unsigned char[16]	RW	-	115	113/6	0xF130...0xF137/ 61745...61752

With this parameter, the instrument can be given a custom tag name, with a maximum of 16 characters.

Customer Model

Type	Access	Range	FlowDDE	FLOW-BUS	Modbus
Unsigned char[16]	RW 	-	93	113/4	0xF120...0xF127/ 61729...61736

This parameter is used to add extra information to the model number information, such as a customer-specific model number.

Serial Number

Type	Access	Range	FlowDDE	FLOW-BUS	Modbus
Unsigned char[20]	R 	-	92	113/3	0xF118...0xF11F/ 61721...61728

Instrument serial number for identification.

BHT Model Number

Type	Access	Range	FlowDDE	FLOW-BUS	Modbus
Unsigned char[35]	RW 	-	91	113/2	0xF110...0xF117/ 61713...61720

This parameter shows the Bronkhorst® instrument model type information.

Firmware Version

Type	Access	Range	FlowDDE	FLOW-BUS	Modbus
Unsigned char[6]	R	-	105	113/5	0xF128...0xF12A/ 61737...61739

Revision number of the firmware

Identification Number

Type	Access	Range	FlowDDE	FLOW-BUS	Modbus
Unsigned char	RW 	0...255	175	113/12	0x0E2C/3629

Bronkhorst® (digital) device type identification number.

Device Type

Type	Access	Range	FlowDDE	FLOW-BUS	Modbus
Unsigned char[6]	R	-	90	113/1	0xF108...0xF10A/ 61705...61707

Device type information string; this parameter contains an abbreviation referring to the identification number.

3.9.4 Alarms and counter

*Alarm and counter settings are most easily accessible via FlowPlot or FlowView software or a Bronkhorst® readout and control unit (E-8000 or BRIGHT).
For more information about the alarm and counter parameters, see the according sub sections under [Advanced parameters and properties](#).*

3.10 Adjusting zero point

The zero point (the signal that corresponds to zero flow) of a Bronkhorst® flow meter/controller is factory adjusted at approximately 20 °C and atmospheric pressure, with the instrument in an upright position. If the ambient conditions or mounting position are significantly different, the instrument might detect a flow when actually there is none. In that case, the instrument needs to be adapted to the new conditions by re-adjusting the zero point.

Zeroing an instrument requires that:

- the ambient conditions (temperature, pressure) match those of the operating environment of the instrument
- the instrument is filled homogeneously with the operational media
- there is absolutely no flow through the instrument; preferably, this is achieved by closing a valve immediately after the outlet of the instrument (control valve, shut-off valve)



Blocking the flow through the instrument is absolutely essential; zeroing an instrument while there is still a flow will lead to measurement errors.



Adjusting the zero point of an instrument can be done by the following methods:

- manually (using the multifunctional switch)
- digitally (via RS232 or fieldbus)
- with the autozero function of a Bronkhorst® readout and control unit (E-8000/BRIGHT)

Once started, the procedure takes approximately 5 seconds to complete (longer if the output signal is unstable), regardless of the preferred method.

3.10.1 Manual procedure

To start the built-in autozero function with the multifunctional switch, follow these instructions:

1. Change the setpoint of the instrument to 0 (zero)
2. Press and hold the multifunctional switch. After 4 seconds, the red LED  starts glowing for 4 seconds, after which the green LED  starts glowing
3. At that moment (which is after 8 to 12 seconds), release the switch

The green LED starts to blink fast, indicating that the autozero function is being performed. On (successful) completion, the green LED starts to glow continuously, while the output signal is 0% (parameter *Measure* = 0).

3.10.2 Digital procedure



FlowPlot provides an easy way to adjust the zero point of an instrument via RS-232; the Auto zero function automatically performs the procedure described here

To adjust the zero point using digital communication, set parameter values in the following sequence (see section [Basic parameters and properties](#) for more information about instrument parameters):

Sequence #	Parameter	Value	Action
1	Setpoint	0	stop flow (close control valve)
2	Init Reset	64	unlock secured parameters
3	Control Mode	9	enable calibration mode
4	Calibration Mode	0	reset calibration mode
5	Calibration Mode	9	start zeroing

The green LED starts to blink fast, indicating that the zeroing procedure is being performed. On completion, the green LED starts to glow continuously, while the output signal is 0% (parameter *Measure* = 0). At the same time, parameter *Control Mode* returns to its initial value. If the procedure is successful, parameter *Calibration Mode* changes to 0 (idle). If the procedure fails, *Calibration Mode* changes to 255.



After performing the procedure, remember to set parameter Init Reset to value 0 to lock secured parameters

4 Advanced operation

4.1 Sealing material compatibility

EL-FLOW® Prestige instruments are fitted from factory with internal seals compatible with the gas type(s) as specified at ordering time. Before using other media, always check their compatibility with the applied sealing materials. Check the [model key](#) on the serial number label to see which sealing materials have been incorporated in your specific instrument. When in doubt, do not hesitate to contact your Bronkhorst representative for more information.

The table below lists compatibility with some commonly used gases:

Gas	Sealing material		
	Viton®	EPDM	Kalrez®/FFKM
Air	✓	✓	✓
Ar (Argon)	✓	✓	✓
CH ₄ (Methane)	✓	✗	✓
CO (Carbon monoxide)	✓	✓	✓
CO ₂ (Carbon dioxide)	max 10 bar(g), 50°C	✓	max 10 bar(g), 50°C (ED compound ¹ max 30 bar(g))
C ₂ F ₆ (Freon-116)	✓	✓	✓
C ₂ H ₂ (Acetylene)	✓/✗ ²	✓	✓
C ₂ H ₄ (Ethylene)	max 10 bar(g) ³	max 10 bar(g)	max 10 bar(g)
C ₂ H ₆ (Ethane)	✓	✗	✓
C ₃ H ₆ #2 (Propylene)	max 10 bar(g)	✗	max 58 bar(g) ³
C ₃ H ₈ (Propane)	✓	✗	✓
Cl ₂ (Chlorine)	✓	✗	✓
He (Helium)	✓	✓	✓
H ₂ (Hydrogen)	✓	✓	✓
H ₂ S (Hydrogen sulfide)	✗	✓	✓
Kr (Krypton)	✓	✓	✓
NF ₃ (Nitrogen trifluoride)	✗	✗	✓
NH ₃ (Ammonia)	✗	✓	✓
NO (Nitric oxide)	✗	✗	✓
N ₂ (Nitrogen)	✓	✓	✓
N ₂ O (Nitrous oxide)	max 20 bar(g), 50°C	✓	✓
O ₂ (Oxygen)	✓	✓	✓
SF ₆ (Sulfur hexafluoride)	✗	✓	✓
SiH ₄ (Silane)	✓/✗ ²	✗	✓
Xe (Xenon)	✓	✓	✓

1) ED: Explosive Decompression resistant

2) Only O-ring seals, not suitable for control valve plunger

3) For higher pressures ED compounds are used



- Always make sure that the used process gases or mixtures thereof are compatible with the sealing materials the instrument is equipped with.
- Do not exceed the specified maximum operating pressure and temperature. Using the instrument outside the specified operating limits might lead to serious damage and dangerous situations.
- The gas(es) used in the fluid system in which the instrument is mounted should be clean and dry.

4.2 Advanced parameters and properties

4.2.1 Measurement and control (advanced)

Fmeasure

Type	Access	Range	FlowDDE	FLOW-BUS	Modbus
Float	R	-3.4E+38... 3.4E+38	205	33/0	0xA100...0xA101/ 41217...41218

Floating point variant of *Measure*. *Fmeasure* shows the measured value in the capacity unit for which the instrument is set. The instrument uses parameters *Capacity*, *Capacity 0%*, *Capacity Unit* and *Sensor Type* to calculate *Fmeasure*.

Fsetpoint

Type	Access	Range	FlowDDE	FLOW-BUS	Modbus
Float	RW	0...3.4E+38	206	33/3	0xA119...0xA11A/ 41241...41242

Floating point variant of *Setpoint*. *Fsetpoint* shows the setpoint in the capacity unit for which the instrument is set. Like *Fmeasure*, *Fsetpoint* is dependent of *Capacity*, *Capacity 0%*, *Capacity Unit* and *Sensor Type*.

Setpoint Slope

Type	Access	Range	FlowDDE	FLOW-BUS	Modbus
Unsigned int	RW	0...30000	10	1/2	0x0022/35

The value of this parameter represents the time it would take to adjust the setpoint if it were changed from 0 to 100%. This feature can be used to smooth 'nervous' controller behavior, e.g. to reduce setpoint overshoot or undershoot. The supported range corresponds to 0...3000 seconds. Default value = 0.

Example:

If *Setpoint Slope* = 100 it will take 10 seconds to adjust the setpoint if it is changed from 0 to 100%. A setpoint change of 20% will take $(20\%/100\%)*10$ seconds = 2 seconds.

Analog Input

Type	Access	Range	FlowDDE	FLOW-BUS	Modbus
Unsigned int	R	0...65535	11	1/3	0x0023/36

This parameter contains a digital translation of the analog input signal (if applicable).

Valve Output

Type	Access	Range	FlowDDE	FLOW-BUS	Modbus
Unsigned long	RW	0... 16777215	55	114/1	0xF208...0xF209/61961...61962

This parameter represents the controller output signal for control valve operation.

Sensor Type

Type	Access	Range	FlowDDE	FLOW-BUS	Modbus
Unsigned char	RW 	0...255	22	1/14	0x002E/47

For the EL-FLOW® Prestige the following values are valid:

- 3: Gas flow sensor, controller enabled
- 131: Gas flow sensor, controller disabled

4.2.2 Special parameters

Init Reset

Type	Access	Range	FlowDDE	FLOW-BUS	Modbus
Unsigned char	RW	82/64	7	0/10	0x000A/11

Init Reset is used to unlock secured parameters (marked with a  symbol) for writing. It supports the following values:

Value	Description
64	unlocked, secured parameters can be read and written to
82	locked, secured parameters are read-only

At power-up, *Init Reset* is always set to 'Locked' (value 82).

Reset

Type	Access	Range	FlowDDE	FLOW-BUS	Modbus
Unsigned char	R	0...7	114	115/8	0x0E68/3689

This parameter is used to reset the program, counter or alarms.

Value	Description
0	No reset
1	Reset counter
2	Reset alarm
3	Reset counter
4	Reset and disable counter
5	Reset firmware program (soft reset)
6	Reset <i>Alarm info</i> error bit
7	Reset <i>Alarm info</i> warning bit



The Reset parameter may be disabled by Reset Alarm Enable or Reset Counter Enable. Make sure the value is accepted by sending value 0 first.

Wink

Type	Access	Range	FlowDDE	FLOW-BUS	Modbus
Unsigned char [27]	W	0...9*	1	0/0	0x0000/1

Sending any text string value between 1 and 9 to this parameter makes the indication LEDs (if present) blink for a couple of seconds. This can be useful in order to identify a specific device in a large fieldbus network.

*) Modbus only supports value 14592

Control Mode

Type	Access	Range	FlowDDE	FLOW-BUS	Modbus
Unsigned int	RW	0...255	12	1/4	0x0024/37

Control Mode is used to select different control modes of the instrument and determines from which source(s) it accepts a setpoint. The following control modes are available:

Value	Mode	Instrument action	Setpoint source
0	BUS/RS232	Controlling	Fieldbus/RS-232
1	Analog Input	Controlling	Analog input
2	FLOW-BUS Slave	Acting as slave instrument on FLOW-BUS	RS-485 only: FLOW-BUS master output x <i>Slave Factor</i> /100%
3	Valve Close	Controller disabled, valve closed	
4	Controller Idle	Controller disabled, valve frozen in current position	

Value	Mode	Instrument action	Setpoint source
7	Setpoint 100%	Controlling, setpoint fixed to 100%	
8	Valve Fully Open	Controller disabled, valve fully opened	
9	Calibration Mode	Calibration mode enabled (factory only)	
10	Analog Slave	Acting as slave of other instrument in analog mode	<i>Analog Input</i> x <i>Slave Factor</i> /100%
12	Setpoint 0%	Controlling, setpoint fixed to 0%	
13	FLOW-BUS Analog Slave	Acting as slave of other instrument on FLOW-BUS, slave factor is set by analog input signal	RS-485 only: FLOW-BUS master output x <i>Analog Input</i>
18	RS232	Controlling, safe state deactivated	Fieldbus/RS-232
20	Valve Steering	Controller disabled, setpoint redirected to <i>Valve output</i>	
21	Analog Valve Steering	Controller disabled, analog input redirected to <i>Valve output</i>	
22	Valve Safe State	Force instrument in safe state	

Immediately after power-up, *Control Mode* is set to 'Analog input' or 'BUS/RS232' automatically, depending on the (requested) default setting for analog or digital operation. If *Control mode* is set to value 0, 1, 9 or 18, the instrument returns to its default control mode at the next power-up or reset. Other values are retained after power-up or reset.



- See section [Changing default control mode](#) for more information about the default control mode.
- See section [Control mode - readout/change](#) for information about changing the control mode using the multifunctional switch.
- Parameter values 3, 8, 20 and 21 can be used regardless if the controller is enabled or not. See also parameter *Sensor Type*
- Control Mode values 2 and 13 are only effective in a FLOW-BUS system; see also section [Master/slave configuration \(FLOW-BUS\)](#).

4.2.3 Fluid set



For changing fluid, flow range or operating conditions, using the FlowTune software is strongly advised. FlowTune checks any changes for compatibility of the process conditions with the instrument. When the parameters described in this section are changed manually, no such checks are performed, and the instrument output may become disordered or the instrument may even get damaged if used in conditions the instrument is not suited for. When in doubt, consult your Bronkhorst representative.

Fluid Set Index

Type	Access	Range	FlowDDE	FLOW-BUS	Modbus
Unsigned char	RW	0..7	24	1/16	0x0030/49

With this parameter, any of the pre-configured fluids (up to 8) can be selected. Each fluid has its specific (configurable) properties, such as *Fluid Name*, *Capacity*, etc.
Default value: 0 (fluid 1).

Note that the selected value is equal to the fluid number minus 1 (value 0 corresponds to fluid 1, value 1 to fluid 2, etc.)

Fluid Name

Type	Access	Range	FlowDDE	FLOW-BUS	Modbus
Unsigned char[10]	RW	-	25	1/17	0x8188...0x818C/33161...33165

This parameter contains the name of the current fluid.

Capacity

Type	Access	Range	FlowDDE	FLOW-BUS	Modbus
Float	RW 	1E-10... 1E+10	21	1/13	0x8168...0x8169/33129...33130

This parameter sets the maximum readout/control value (100%) for the current fluid in readout units corresponding to *Capacity Unit*.

Capacity Unit

Type	Access	Range	FlowDDE	FLOW-BUS	Modbus
Unsigned char[7]	RW 	see below	129	1/31	0x81F8...0x81FB/33273...33276

Available units:

Mass flow	Normal volume flow (1.01325 bar(a), 0 °C)	Standard volume flow (1.01325 bar(a), 20 °C)	Custom volume flow (<i>Capacity Unit Type Pressure</i> , <i>Capacity Unit Type Temperature</i>)
ug/h, ug/min, ug/s, mg/h, mg/min, mg/s, g/h, g/min, g/s, kg/h, kg/min, kg/s	uln/h, uln/min, uln/s, mln/h, mln/min, mln/s, ln/h, ln/min, ln/s, ccn/h, ccn/min, ccn/s, mm3n/h, mm3n/m, mm3n/s, cm3n/h, cm3n/m, cm3n/s, m3n/h, m3n/min, m3n/s, scfh, scfm, scfs, sccm, slm	uls/h, uls/min, uls/s, mls/h, mls/min, mls/s, ls/h, ls/min, ls/s, ccs/h, ccs/min, ccs/s, mm3s/h, mm3s/m, mm3s/s, cm3s/h, cm3s/m, cm3s/s, m3s/h, m3s/min, m3s/s	ul/h, ul/min, ul/s, ml/h, ml/min, ml/s, l/h, l/min, l/s, cc/h, cc/min, cc/s, mm3/h, mm3/m, mm3/s, cm3/h, cm3/m, cm3/s, m3/h, m3/min, m3/s, cfh, cfm, cfs



Because of the maximum string length (7 characters), some unit names are abbreviated. For instance mm3n/m means mm³n/min.

Capacity Unit Type Temperature

Type	Access	Range	FlowDDE	FLOW-BUS	Modbus
Float	RW 	-273.15... 3.4E+38	245	33/10	0xA150...0xA151/41297...41298

This parameter defines a reference temperature for conversion of the measured mass flow to a volume flow. See also parameters *Capacity Unit* and *Counter Unit*.

Capacity Unit Type Pressure

Type	Access	Range	FlowDDE	FLOW-BUS	Modbus
Float	RW 	0...3.4E+38	246	33/11	0xA158...0xA159/41305...41306

This parameter defines a reference pressure for conversion of the measured mass flow to a volume flow. See also parameters *Capacity Unit* and *Counter Unit*.

Controller Speed

Type	Access	Range	FlowDDE	FLOW-BUS	Modbus
Float	RW	0.2...5	254	114/30	0xF2F0...0xF2F1/62193...62194

This parameter sets the overall controller speed factor for the selected fluid set. *Controller Speed* is set ex factory between value '0.5' (slow) and '2' (fast). The default value is '1'. Slower or faster settings are possible between values 0.2 and 5 at the customer's responsibility.

4.2.3.1 Advanced fluid set parameters



Note that the parameters described in this section do not contain any actual measurement values, but only fixed reference values, which can be used for capacity calculations, etc.

Inlet Pressure

Type	Access	Range	FlowDDE	FLOW-BUS	Modbus
Float	RW	0...3.4E+38	178	113/13	0xF168...0xF169/61801...61802

Inlet pressure of the current fluid in bar(a)

Outlet Pressure

Type	Access	Range	FlowDDE	FLOW-BUS	Modbus
Float	RW	0...3.4E+38	179	113/14	0xF170...0xF171/61809...61810

Outlet pressure of the current fluid in bar(a).

Fluid Temperature

Type	Access	Range	FlowDDE	FLOW-BUS	Modbus
Float	RW	-250...500	181	113/16	0xF180...0xF181/61825...61826

Temperature of the current fluid in °C.

Density

Type	Access	Range	FlowDDE	FLOW-BUS	Modbus
Float	RW	0...3.4E+38	170	33/21	0xA1A8...0xA1A9/41385...41386

Density of the current fluid in kg/m³

Heat Capacity

Type	Access	Range	FlowDDE	FLOW-BUS	Modbus
Float	RW	0...3.4E+38	250	113/18	0xF190...0xF191/61841...61842

Heat capacity of the current fluid in J/kg-K

Thermal Conductivity

Type	Access	Range	FlowDDE	FLOW-BUS	Modbus
Float	RW	0...3.4E+38	251	113/20	0xF1A0...0xF1A1/61857...61858

Thermal conductivity of the current fluid in W/m-K

Viscosity

Type	Access	Range	FlowDDE	FLOW-BUS	Modbus
Float	RW	0...3.4E+38	252	113/21	0xF1A8...0xF1A9/61865...61866

Dynamic viscosity of the current fluid in Pa-s

4.2.3.2 Fluid mixture parameters

Mix Fraction Type

Type	Access	Range	FlowDDE	FLOW-BUS	Modbus
Unsigned char	RW	0...2	346	126/4	0x0FC4/4037

Set the fraction type of the mixture:

Value	Description
0	Volume fraction
1	Mass fraction
2	Mole fraction

Mix Volume Temperature

Type	Access	Range	FlowDDE	FLOW-BUS	Modbus
Float	RW	-250...500	347	126/5	0xFE28...0xFE29/65065...65066

Temperature of the mixture in °C. The value of this parameter is only relevant if *Mix Fraction Type* = 0.

Mix Volume Pressure

Type	Access	Range	FlowDDE	FLOW-BUS	Modbus
Float	RW	0...3.4E+38	348	126/6	0xFE30...0xFE31/65073...65074

Pressure of the mixture in bar(a). The value of this parameter is only relevant if *Mix Fraction Type* = 0.

Mix Component Index

Type	Access	Range	FlowDDE	FLOW-BUS	Modbus
Unsigned char	RW	0...4	349	126/7	0x0FC7/4040

Index of the current component in the mixture (max. 5 components).

Mix Component Fraction

Type	Access	Range	FlowDDE	FLOW-BUS	Modbus
Float	RW	0...1	350	126/8	0xFE40...0xFE41/65089...65090

Mix fraction of the current mix component (*Mix Component Index*). The value range corresponds to 0...100%. The sum of the all mix fractions must be equal to 1.

If the value is 0, the next component slots are ignored.

Mix Component Fluid Name

Type	Access	Range	FlowDDE	FLOW-BUS	Modbus
Unsigned char[10]	RW	-	351	126/9	0xFE48...0xFE4C/65097...65101

This parameter contains the fluid name of the current mix component (*Mix Component Index*). This parameter may contain one of two value types:

- Gas name, e.g. 'N2', 'He', 'C3H6 #2'.
- CAS Registry Number, e.g. '7727-37-9', '7440-59-7', '115-07-1'

If the parameter contains no name, the next component slots are ignored.

4.2.4 Alarms



Alarm settings are most easily accessible using FlowPlot or FlowView or a Bronkhorst® readout and control unit.

The built-in alarm functionality can be used to handle different alarm types:

- system errors and warnings
- min/max alarms
- response alarms
- batch alarms
- master/slave alarms

The used alarm type can be set with parameter *Alarm Mode*. When an alarm is activated, the type can be read out using parameter *Alarm Info*. An automatic setpoint change can be set using the parameters *Alarm Setpoint Mode* and *Alarm New Setpoint*. It is also possible to set an alarm delay, to prevent overreaction to small disturbances, using parameter *Alarm Delay Time*. The methods by which an alarm can be reset are controlled by *Reset Alarm Enable*.

Alarm Mode

Type	Access	Range	FlowDDE	FLOW-BUS	Modbus
Unsigned char	RW	0..3	118	97/3	0x0C23/3108

Available modes:

Value	Description
0	Alarm off
1	Alarm on absolute limits
2	Alarm on limits related to setpoint (response alarm)
3	Alarm at power-up(e.g. after power-down)

(On DeviceNet™ instruments, only modes 0 and 1 are available)

Alarm Info

Type	Access	Range	FlowDDE	FLOW-BUS	Modbus
Unsigned char	R	0..255	28	1/20	0x0034/53

This parameter provides information about the event type(s) that triggered an alarm situation. The value is a bitwise summation of the issued alarm types; convert the value to binary to see which types are issued. The following alarm types can be issued:

Bit	Value	Type	Description
0	1	Error	Error flag raised
1	2	Warning	Warning flag raised
2	4	Minimum alarm	<i>Measure < Alarm minimum limit</i>
3	8	Maximum alarm	<i>Measure > Alarm maximum limit</i>
4	16	Batch counter alarm	Batch counter reached its limit
5	32	<ul style="list-style-type: none"> • This bit only: Power-up alarm • If combined with bit 2 or 3: Response alarm 	Alarm possibly caused by a power dip Difference between <i>Measure</i> and <i>Setpoint</i> too big
6	64	Master/slave alarm	Setpoint out of limits (caused by <i>Slave factor</i>)
7	128	Hardware alarm	Hardware error

Alarm Delay Time

Type	Access	Range	FlowDDE	FLOW-BUS	Modbus
Unsigned char	RW	0..255	182	97/7	0x0C27/3112

This value represents the time in seconds the alarm action will be delayed when an alarm limit has been exceeded. This value also delays the alarm off action if an alarm limit is no longer exceeded.
Default value = '0'.

Alarm Maximum Limit

Type	Access	Range	FlowDDE	FLOW-BUS	Modbus
Unsigned int	RW	0...32000	116	97/1	0x0C21/3106

Maximum limit for *Measure* to activate the maximum alarm situation (after *Alarm Delay Time*). Range 0...32000 represents 0...100% signal. *Alarm Maximum Limit* must be greater than *Alarm Minimum Limit*.
Default value: 0.

Alarm Minimum Limit

Type	Access	Range	FlowDDE	FLOW-BUS	Modbus
Unsigned int	RW	0...32000	117	97/2	0x0C22/3107

Minimum limit for *Measure* to activate the minimum alarm situation (after *Alarm Delay Time*). Range 0...32000 represents 0...100% signal. *Alarm Minimum Limit* must be smaller than *Alarm Maximum Limit*.
Default value: 0.

Alarm Setpoint Mode

Type	Access	Range	FlowDDE	FLOW-BUS	Modbus
Unsigned char	RW	0...1	120	97/5	0x0C25/3110

Specifies whether or not to change the setpoint after an alarm situation is activated.

Value	Description
0	No setpoint change (default)
1	Change setpoint to <i>Alarm new setpoint</i>

Alarm New Setpoint

Type	Access	Range	FlowDDE	FLOW-BUS	Modbus
Unsigned int	RW	0...32000	121	97/6	0x0C26/3111

New (safe) setpoint during an alarm until reset. Range 0...32000 represents 0...100% setpoint.
Default value: 0

Reset Alarm Enable

Type	Access	Range	FlowDDE	FLOW-BUS	Modbus
Unsigned char	RW	0...15	156	97/9	0x0C29/3114

Available reset methods for alarms. Up to 4 different methods can be specified; convert the value to binary to see which methods are enabled.
Default value: 15 (all bits/methods enabled)

The following methods are supported:

Bit	Value	Description
0	1	Multifunctional switch
1	2	Externally (deprecated)
2	4	By parameter <i>Reset</i>
3	8	Automatically (when alarm conditions no longer apply)

4.2.5 Counter

Counter settings are most easily accessible using *FlowPlot* or *FlowView* or a *Bronkhorst®* readout and control unit.

Counter Mode

Type	Access	Range	FlowDDE	FLOW-BUS	Modbus
Unsigned char	RW	0...2	130	104/8	0x0D08/3337

Available modes:

Value	Description
0	Counter off (default)
1	Counting up continuously
2	Counting up until limit reached (set by <i>Counter Limit</i>)

Counter Unit

Type	Access	Range	FlowDDE	FLOW-BUS	Modbus
Unsigned char[4]	RW	see table below	128	104/7	0xE838...0xE839/59449...59450

This parameter contains the name of the counter readout unit.

Counter Unit supports the following values:

Mass	Normal volume (1.01325 bar(a), 0 °C)	Standard volume (1.01325 bar(a), 20 °C)	Custom volume (<i>Capacity Unit Pressure</i> , <i>Capacity Unit Type</i> <i>Temperature</i>)
ug, mg, g, kg	uln, mln, ln, mm3n, cm3n, dm3n, m3n	uls, mls, ls, mm3s, cm3s, dm3s, m3s	ul, ml, l, mm3, cm3, dm3, m3

Counter Value

Type	Access	Range	FlowDDE	FLOW-BUS	Modbus
Float	RW	0... 10000000	122	104/1	0xE808...0xE809/59401...59402

Current counter value in units selected with parameter *Counter Unit*.

Counter Limit

Type	Access	Range	FlowDDE	FLOW-BUS	Modbus
Float	RW	0...9999999	124	104/3	0xE818...0xE819/59417...59418

Counter limit/batch size in units selected with parameter *Counter Unit*.

Default value: 0.

Counter Setpoint Mode

Type	Access	Range	FlowDDE	FLOW-BUS	Modbus
Unsigned char	RW	0...1	126	104/5	0x0D05/3334

Specifies whether or not to change the setpoint after reaching the counter limit.

Value	Description
0	No setpoint change (default)
1	Change setpoint to <i>Counter new setpoint</i>

Counter New Setpoint

Type	Access	Range	FlowDDE	FLOW-BUS	Modbus
Unsigned int	RW	0...32000	127	104/6	0x0D06/3335

New (safe) setpoint when a counter limit is reached until reset. Range 0...32000 represents 0...100% setpoint.

Default value: 0

Reset Counter Enable

Type	Access	Range	FlowDDE	FLOW-BUS	Modbus
Unsigned char	RW	0...15	157	104/9	0x0D09/3338

Available reset methods for counters. Up to 3 different methods can be specified. The value is a bitwise summation of the enabled reset methods; convert the value to binary to see which methods are enabled.
Default value: 7 (bits/methods 0, 1 and 2 enabled)

The following methods are supported:

Bit	Value	Description
0	1	Micro-switch
1	2	Externally
2	4	By parameter <i>Reset</i>
3	8	Automatically (e.g. when counter value is reset)

4.2.6 Network configuration

Changes made to the network settings will **not** be restored by a factory reset.

Communication via fieldbus connection (RS485)

Use the following parameters to configure the instrument for communication via the fieldbus connection on top of the instrument (parameter values can be changed via the RS232 interface):

Fieldbus 1 Address

Type	Access	Range	FlowDDE	FLOW-BUS	Modbus
Unsigned char	RW	0...255	199	125/10	0x0FAA/4011

Fieldbus 1 Baud Rate

Type	Access	Range	FlowDDE	FLOW-BUS	Modbus
Unsigned long	RW	0...1.0E10	201	125/9	0xFD48...0xFD49/64841...64842

Fieldbus 1 Parity

Type	Access	Range	FlowDDE	FLOW-BUS	Modbus
Unsigned char	RW	0...2	335	125/12	0x0FAC/4013

The following values are supported:

Value	Description
0	No parity
1	Odd parity
2	Even parity

Communication via power supply connection (RS232/RS485)

Use the following parameters to configure the instrument for communication via the 9-pin D-sub connector on the side of the instrument:



- If the 9-pin D-sub connector is set for RS-485 communication, the instrument will not respond when connected to an RS-232 configuration. In that case, use the power-up functionality of the [multifunctional switch](#) to enter configuration mode and enable RS-232 communication.
- After configuring the required parameters, use the same procedure to leave configuration mode and restore the original communication settings (otherwise, configuration mode remains enabled after power down).

Fieldbus 2 Address

Type	Access	Range	FlowDDE	FLOW-BUS	Modbus
Unsigned char	RW	0...255	309	124/10	0x0F8A/3979

Fieldbus 2 Baud Rate

Type	Access	Range	FlowDDE	FLOW-BUS	Modbus
Unsigned long	RW 	0...1.0E10	310	124/9	0xFC48...0xFC49/64585...64586

Fieldbus 2 Parity

Type	Access	Range	FlowDDE	FLOW-BUS	Modbus
Unsigned char	RW 	0...2	336	124/12	0x0F8C/3981

The following values are supported:

Value	Description
0	No parity
1	Odd parity
2	Even parity

4.2.7 Master/slave configuration (FLOW-BUS)

Normally, there is no communication between slave instruments in a fieldbus system. The FLOW-BUS protocol, however, provides a feature to set up a master/slave relationship between two instruments. The typical behavior of a slave instrument is to automatically set its own setpoint relative to the output (measurement value) of its master.

The output value of any instrument connected to a FLOW-BUS network is automatically available to all other instruments without extra wiring. A slave instrument can in turn be a master to other instruments.

To setup a master/slave relationship between instruments, first determine which instrument should be the master and which should be the slave, then set *Control Mode* of the slave instrument to 'FLOW-BUS Slave' (value 2) or 'FLOW-BUS Analog Slave' (value 13), depending on how the setpoint should be calculated (see parameter [Control Mode](#)).

The slave instrument polls the output value of its master periodically and uses the slave factor to set its own flow relative to the master's.



Setpoints from master instruments can be received via FLOW-BUS only.



To prevent damage to the instruments an/or the system(s) they are connected to, be sure to avoid circular references between devices on the same fieldbus. The FLOW-BUS system does not have a protection mechanism.

Master Node

Type	Access	Range	FlowDDE	FLOW-BUS	Modbus
Unsigned char	RW	1...128	158	33/14	n/a

Set the master node for the instrument

Note that this parameter only is effective in a FLOW-BUS system via RS-485.

Slave Factor

Type	Access	Range	FlowDDE	FLOW-BUS	Modbus
Float	RW	0...500	139	33/1	0xA108...0xA109/41225...41226

The controller output from the master instrument is multiplied by *Slave Factor*/100% to get the slave instrument setpoint. In systems other than FLOW-BUS via RS-485, *Slave Factor* is effective only if *Control Mode* is set to 'Analog slave', and the analog output signal of the master instrument is redirected to the input of the slave instrument.

Example:

- master output = 80%
 - *Slave Factor* = 50
- ⇒ slave instrument setpoint = 80% x 50%/100% = 40%

4.3 Special features

4.3.1 Customized I/O options (pin 5)



EL-FLOW® Prestige instruments offer several customized input/output functions through the 9-pin D-sub side connector as an option. I/O options are factory installed as specified at ordering time, and cannot be changed manually.

The last three characters of the model key on the serial number label indicate the installed I/O configuration (see section [Model key](#)). The possible configurations are described in the table below. See the hook-up diagram for custom bus and I/O configurations (document 9.16.118) for an explanation of the codes.

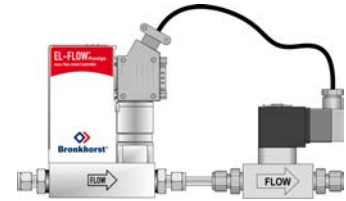
Code	Description
000	Disabled, pin 5 is pulled down to 0 Vdc (default selection)
A1V	<p>0...10 Vdc sourcing output, controller Analog signal for pump or external valve steering (control signal only).</p> <p>When the controller output is used for pump or external valve steering (only applicable to mass flow meters with the controller function enabled), make sure to set parameter <i>Valve maximum</i> to 0.3 [A]. For mass flow controllers, the controller output signal represents the valve actuator current. This output is limited to a value below 10 Vdc, due to the maximum valve current restriction.</p>
B1V	<p>4...20 mA sourcing output, controller Analog signal for pump or external valve steering (control signal only).</p> <p>When the controller output is used for pump or external valve steering (only applicable to mass flow meters with the controller function enabled), make sure to set parameter <i>Valve maximum</i> to 0.3 [A]. For mass flow controllers, the controller output signal represents the valve actuator current. This output is limited to a value below 20 mA, due to the maximum valve current restriction.</p>
B2V	<p>3.8...20.8 mA sourcing output, controller Analog signal for Badger Meter valve with TEIP11 signal converter (control signal only)</p>
C3A	<p>Digital output, min/max alarm During a min/max alarm, pin 5 is pulled down to 0 Vdc.</p>
C4A	<p>Digital output, counter alarm During a counter alarm, pin 5 is pulled down to 0 Vdc.</p>
C5S	<p>Digital output, enabled by setpoint (for shut-off control) Pin 5 is pulled down to 0 Vdc at a controller setpoint, e.g. for shut-off valve activation.</p> <p>For factory selected analog control (...-A#-C5S): If parameter <i>Control mode</i> is set for analog control by factory, the minimum setpoint at which the device (shut-off valve) connected to pin 5 is activated is 1.9%. This prevents possible noise on the analog input activating the device accidentally.</p> <p>For factory selected digital control (...-D#-C5S): If parameter <i>Control mode</i> is set for digital control by factory, the setpoint threshold for activating the device connected to pin 5 is any value > 0.</p> <p>Note: If the instrument is forced into Valve Safe State, the digital output is not affected, so a (n/c) shut-off valve connected to pin 5 will not close when the (n/c) controller is in Valve Safe State'</p> <p>Make sure to use 24 Vdc power supply corresponding to the shut-off valve specifications. Cable 7.03.572 (T-part 9-pin D-sub/loose end) or 7.03.603 (T-part 9-pin D-sub/DIN43650C) can be used for this operating option.</p>

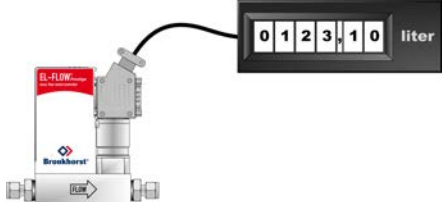

Example for C5S or C0I hook-up

Code	Description
C0I	<p>Digital output, high/low switch via remote parameter (e.g. for shut-off valve control) Pin 5 is pulled down to 0 Vdc when writing value 1 to parameter <i>IO switch status</i>, this is undone by writing value 0.</p> <p>A device connected to pin 5 (e.g. a shut-off valve) can be activated/deactivated by writing parameter <i>IO switch status</i>.</p> <p>Note: If the instrument is forced into Valve Safe State, the digital output is also affected, so a (n/c) shut-off valve connected to pin 5 will be closed when the (n/c) controller is in 'Valve Safe State'.</p> <p>Make sure to use 24 Vdc power supply corresponding to the shut-off valve specifications. Cable 7.03.572 (T-part 9-pin D-sub/loose end) or 7.03.603 (T-part 9-pin D-sub/DIN43650C) can be used for this operating option.</p>
D9E	<p>Digital frequency output, measure Measurement value is translated to a frequency within given frequency range.</p> <p>The default frequency range to represent 0...100% flow is 0...10000 Hz. Any other frequency range must be specified on order.</p>
F9B	<p>Digital pulse output, batch counter Pin 5 is pulled down to 0 Vdc when a given batch size is reached (during a given pulse length).</p> <p>By default, a pulse is given at each 1x the <i>Counter unit</i> batch value, with a pulse length of 1 second. For instance, when <i>Counter unit</i> is set to 'ln', a pulse is given each time 1 ln has passed through the instrument. An alternative pulse length must be specified on order.</p> <p>Provide a pull-up resistor of 5...10 kOhm to create 15...24 Vdc at pin 5 (according to the applicable hook-up diagram).</p>  <p style="text-align: center;">Example for F9B hook-up</p>
H1P*	<p>4...20 mA input, external pressure sensor for active pressure correction. Signal is translated to parameter <i>Pressure</i>.</p>
I3C	<p>Digital input, controller mode valve close Valve closes when pin 5 is connected to 0 Vdc.</p> <p>This option switches between the default <i>Control mode</i> and mode 'Valve Close' (value 3). When the default <i>Control mode</i> is digital, the default value is 0 (bus/RS232), when the default <i>Control mode</i> is analog, the default value is 1 (Analog input).</p>
I8C	<p>Digital input, controller mode valve purge Valve is fully opened when pin 5 is connected to 0 Vdc.</p> <p>This option switches between the default <i>Control mode</i> and mode 'Valve Fully Open' (value 8). When the default <i>Control mode</i> is digital, the default value is 0 (bus/RS232), when the default <i>Control mode</i> is analog, the default value is 1 (Analog input).</p>
I1R	<p>Digital input, reset counter The counter resets when pin 5 is connected to 0 Vdc.</p>  <p style="text-align: center;">Example for I1R or I2R hook-up</p>
I2R	<p>Digital input, reset alarm The alarm resets when pin 5 is connected to 0 Vdc.</p>



***) Note regarding active pressure correction:**

This option overrides the built-in active pressure correction of the EL-FLOW® Prestige PI.

4.3.2 Changing default control mode

IO Status

Type	Access	Range	FlowDDE	FLOW-BUS	Modbus
Unsigned char	RW 	0...255	86	114/11	0x0E4B/3660

The instrument is set to accept a setpoint from either an analog or a digital source. Although this setting can be changed with parameter [Control Mode](#), the instrument usually returns to its default control mode at every power-up or reset. The default control mode can be set with parameter *IO Status*; to change it, use the procedures as described below.

Changing from digital operation to analog operation:

1. Set parameter *Init Reset* to 64 (unlocked)
2. Read parameter *IO Status*
3. Add 64 to the read value
4. Write the new value to parameter *IO Status*
5. Set parameter *Init Reset* to 82 (locked)

Changing from analog operation to digital operation:

1. Set parameter *Init Reset* to 64 (unlocked)
2. Read parameter *IO Status*
3. Subtract 64 from the read value
4. Write the new value to parameter *IO Status*
5. Set parameter *Init Reset* to 82 (locked)



The procedures described above do not change the value of parameter *Control Mode* directly. To apply the new default control mode immediately, change the value of parameter *Control Mode* manually or reset or restart the instrument.

5 Troubleshooting and service

To track down problems in the fluid system, it is recommended to disconnect the unit from the process line and check it without applying fluid pressure. Dirt or clogging might be detected quickly by loosening fluid connections and performing a visual inspection.

Energizing and de-energizing the equipment can indicate whether there is an electronic failure. After energizing, control behavior can be checked by applying fluid pressure.



If you suspect leakage, do not disassemble the device for inspection, but contact your Bronkhorst representative for service or repairs.

5.1 Errors and warnings



See [LED indications](#) for an explanation of the possible LED indications the instrument can give.



In case of problems during operation, error and warning information can be found in FlowDDE and FlowPlot. FlowDDE puts all errors and warnings on the console screen; in FlowPlot, the Alarm & Count tab (Instrument Settings) provides several specific alarm and counter indicators.

5.2 Restoring factory settings

In case changes to the instrument configuration leads to non-recoverable erroneous behavior, the instrument can be reset to the pre-configured factory settings. This can be done with the following methods:

- with the multifunctional switch (see [Micro switch functions](#))
- with the *restore* function of a Bronkhorst® readout and control unit (BRIGHT, E-8000)
- via RS232 communication, with the *Restore settings* function in FlowPlot

To restore the factory settings using the multifunctional switch, follow these instructions:

1. Make sure electrical power to the instrument is switched off
2. Press and hold the multifunctional switch, while powering up the instrument. After 4 seconds, the red LED ● starts flashing (0.2 seconds on, 0.2 seconds off)
3. At that moment (which is after 4 to 8 seconds), release the switch



*Changes made to the network settings (bus address, baud rate, parity) will **not** be restored by a factory reset.*



If digital communication with the instrument can not be re-established, see [Micro switch functions](#) to overrule the actual 9-pin D-sub communication settings with the configuration mode and use the RS232 communication mode to re-establish communication.

5.3 Common issues

Symptom	Possible cause	Action
No power (LEDs not burning)	No power supply	Check power supply Check cable connection
	Internal fuse blown due to long lasting shortage	Return to factory
Zero output signal	No setpoint accepted, incorrect control mode	Check analog/digital control mode (see section Special parameters)
	No setpoint given, setpoint too low	Give setpoint >2%
	Valve in 'Safe State' (normally closed valves)	Remove cause of 'Valve Safe State' (see section Valve Safe State)
	Pcb/sensor failure	Return to factory
	Laminar flow element blocked/contaminated	Return to factory
Maximum output signal (131.07%)	Flow too high, valve fully open	Close valve
	Pcb/sensor failure	Return to factory
	Valve in 'Safe State' (normally open valves)	Remove cause of 'Valve Safe State' (see section Valve Safe State)
Setpoint cannot be achieved	Pressure difference across instrument insufficient to achieve requested flow rate	Check inlet/outlet pressure
	Valve blocked or damaged	Return to factory
	Stoppage	Remove contamination
Flow signal is gradually decreasing without setpoint change	Pressure difference across instrument insufficient to achieve requested flow rate	Check inlet/outlet pressure
	Process gas condensation occurs	Decrease pressure or increase gas temperature
Oscillating controller output	Controller adjustment wrong, PID settings too fast	Decrease Controller Speed value
	Inlet/outlet pressure too high or too low	Adjust pressure/set correct instrument pressure with FlowTune™
	Wrong gas selected	Set correct process gas with FlowTune™
	Inlet pressure control is oscillating	Replace pressure regulator or increase buffer volume between controlling instruments (see section Piping requirements)
	'Cross-talk' with other controller instruments in process line	Increase buffer volume between controller instruments (see section Piping requirements)
	Valve is damaged	Return to factory
Non-zero output signal when valve is closed	Valve is leaking (through valve)	Check valve specifications for leak-tightness through valve
	Non-zero offset signal (occurs at upward/downward placement at higher pressures)	See Adjusting zero point

5.4 Service

For current information about Bronkhorst® and service addresses, please visit our website:



www.bronkhorst.com

Do you have any questions about our products? Our Sales Department will gladly assist you selecting the right product for your application. Contact sales by e-mail:



sales@bronkhorst.com

For after-sales questions, our Customer Service Department is available with help and guidance. To contact CSD by e-mail:



support@bronkhorst.com

No matter the time zone, our experts within the Support Group are available to answer your request immediately or ensure appropriate further action. Our experts can be reached at:



+31 859 02 18 66

Bronkhorst High-Tech B.V.
Nijverheidsstraat 1A
NL-7261 AK Ruurlo
The Netherlands

6 Returns

6.1 Removal and return instructions

When returning materials, always clearly describe the problem, and, if possible, the work to be done, in a covering letter.

Instrument handling:

1. Purge all fluid lines (if applicable)
2. If the instrument has been used with toxic or otherwise hazardous fluids, it must be cleaned before shipping
3. Disconnect all external cabling and tubing and remove the instrument from the process line
4. If applicable, secure movable parts with appropriate transport safety materials, to prevent damage during transportation
5. The instrument must be at ambient temperature before packaging
6. Insert the instrument into a plastic bag and seal the bag
7. Place the bag in an appropriate shipping container; if possible, use the original packaging box

Add documentation:

- Reason of return
- Failure symptoms
- Contaminated condition
- Declaration on decontamination



It is absolutely required to notify the factory if toxic or dangerous fluids have been in contact with the device!
This is to enable the factory to take sufficient precautionary measures to safeguard the staff in their repair department.

All instruments must be dispatched with a completely filled in 'Declaration on decontamination'. Instruments without this declaration will not be accepted.



A safety information document containing a 'Declaration on decontamination' form (document no 9.17.032) can be downloaded from the **Service & Support** section of the Bronkhorst website (www.bronkhorst.com).

Important:

Clearly note, on top of the package, the customs clearance number of Bronkhorst High-Tech B.V.:

NL801989978B01

(only if applicable, otherwise contact your Bronkhorst representative for local arrangements.)

6.2 Disposal (end of lifetime)

Within the European Union, manufacturers of electrical and electronic equipment (EEE) are obliged to comply with the WEEE directive (waste electrical and electronic equipment). Bronkhorst offers its customers the possibility to return EEE for disposal at the end of its life, so that it can be properly dismantled and the components recycled or, if possible, reused.

All Bronkhorst® products covered by the WEEE directive (the majority) carry an image of a crossed-out waste bin (usually on the serial number label). If you wish to dispose of Bronkhorst® equipment bearing this symbol, simply return it in accordance with the [removal and return instructions](#), and Bronkhorst will take care of proper dismantling, recycling and/or reuse (wherever possible). In the covering letter, just mention that you are returning the product for disposal. Within the EU, returning products for disposal is of course free of charge (except for shipping and handling costs).



In countries outside the EU, EEE disposal may be subject to local or national directives and/or legislation. If applicable, consult local or national authorities to learn how to handle EEE properly in your area.

Parameter index

Parameters

		Mix Fraction Type	43
		Mix Volume Pressure	43
		Mix Volume Temperature	43
		Parameters - Master/Slave	
		Master Node	48
		Slave Factor	48
		Parameters - Measurement and control	
		Analog Input	38
		Fmeasure	38
		Fsetpoint	38
		Measure	33
		Pressure	34
		Sensor Type	38
		Setpoint	33
		Setpoint Slope	38
		Temperature	34
		Valve Output	38
		Parameters - Network configuration	
		Fieldbus1 Address	47
		Fieldbus1 Baud Rate	47
		Fieldbus1 Parity	47
		Fieldbus2 Address	47
		Fieldbus2 Baud Rate	48
		Fieldbus2 Parity	48
		Parameters - Special	
		Control Mode	39
		Init Reset	39
		IO Status	51
		Reset	39
		Wink	39
Parameters - Alarms			
Alarm Delay Time	44		
Alarm Info	44		
Alarm Maximum Limit	45		
Alarm Minimum Limit	45		
Alarm Mode	44		
Alarm New Setpoint	45		
Alarm Setpoint Mode	45		
Reset Alarm Enable	45		
Parameters - Counter			
Counter Limit	46		
Counter Mode	45		
Counter New Setpoint	46		
Counter Setpoint Mode	46		
Counter Unit	46		
Counter Value	46		
Reset Counter Enable	47		
Parameters - Device identification			
BHT Model Number	34		
Customer Model	34		
Device type	35		
Firmware version	34		
Identification number	35		
Serial Number	34		
User Tag	34		
Parameters - Fluid set			
Capacity	41		
Capacity Unit	41		
Capacity Unit Type Pressure	41		
Capacity Unit Type Temperature	41		
Controller Speed	41		
Fluid Name	40		
Fluid Set Index	40		
Parameters - Fluid set (advanced)			
Density	42		
Fluid Temperature	42		
Heat Capacity	42		
Inlet Pressure	42		
Outlet Pressure	42		
Thermal Conductivity	42		
Viscosity	42		
Parameters - Fluid set (mixture)			
Mix Component Fluid Name	43		
Mix Component Fraction	43		
Mix Component Index	43		